

Tactile Auditory Sensory Substitution

BME 200/300
University of Wisconsin - Madison
December 13, 2006

Team:

Ryan Thome, *Co-Team Leader*
Sarah Offutt, *Co-Team Leader*
Laura Bagley, *Communications*
Amy Weaver, *BSAC*
Jack Page, *BWIG*

Client:

Veronica H. Heide, Au.D.
Audible Difference

Advisor:

Mitchell E. Tyler, P.E., M.S.
Dept. of Biomedical Engineering &
Dept. of Ortho-Rehab Medicine
University of Wisconsin - Madison

Table of Contents

Abstract.....	3
Background.....	4
<i>Sensory Substitution</i>	4
<i>High Frequency Hearing Loss</i>	4
<i>Hearing Aids</i>	6
<i>Existing Products</i>	7
System Diagram.....	8
Tactile Stimulation.....	8
Placement.....	11
Alternate Designs.....	12
Proposed Design.....	13
Final Design.....	14
<i>Cool Edit</i>	15
<i>Sound Card</i>	16
<i>Circuit</i>	16
<i>Transducers</i>	18
<i>Output</i>	18
Future Work.....	19
References.....	21
APPENDIX 1: Project Design Specifications.....	23
APPENDIX 2: Design Matrix.....	26
APPENDIX 3: Systems Diagram.....	27

Abstract

High frequency hearing loss is a problem common among people of all age groups. People suffering from this type of hearing loss often lose the ability to hear certain consonant sounds, and as a result have difficulty communicating with others. The goal of the project is to use sensory substitution, a technique for presenting environmental information missing in one sensory modality to another, to help replace this missing high frequency information. The device takes recorded information, filters it into four different channels based on frequency, then outputs all four channels to a sound card. The sound card outputs to a circuit that amplifies the sound and reduces the noise. The circuit then outputs to four transducers. Use of this device, in conjunction with the lower frequency audio information gathered directly by the user, should allow the user to better communicate by speech and hearing.

Product Design Specifications

The final design should meet several performance, safety and aesthetic specifications. The device needs to adjust to user specific high frequency hearing loss using the programmable functions of a digital signal processing hearing aid already in place. It should recognize and alert the user to sounds above 1000Hz. The device will also use either vibro- or electro-tactile method of stimulation and draw no more than 2 – 10 mA of current from the hearing aid's battery. Because the device will be placed near the ear, no more than 5 mA of current should pass through the device into the user. The device should also heat to no more than 110° F. When in use, the device should be comfortable for the user and not easily noticeable to others.

Background

Sensory Substitution

Sensory substitution is presenting environmental information absent in one sensory modality to another. Sensory substitution can be seen in many actions people perform throughout their everyday lives. For example, a person substitutes the sense of touch for sight when reaching into their pocket to retrieve an object. Other common examples are the use of sign language to substitute vision for hearing and Braille which substitutes the sense of touch for sight. In this project, the device will substitute missing high frequency hearing with electrotactile stimulation.

High Frequency Hearing Loss

The amount of hearing impaired Americans has more than doubled in the past 30 years with nearly 50 percent of Americans over the age of 65 affected (ASHA, 1997-2006). It not only affects the elderly however, 1.4 million children under the age of 18 also have a hearing condition (BHI, 2005-2006). The two most common types of hearing loss are conductive and sensorineural. Conductive hearing loss is defined as the condition when sound is not transmitted correctly through the middle ear and into the inner ear. Some describe it as like having the ears plugged all day. It can be caused by wax buildup or even infection. This type of hearing loss can often be medically cured.

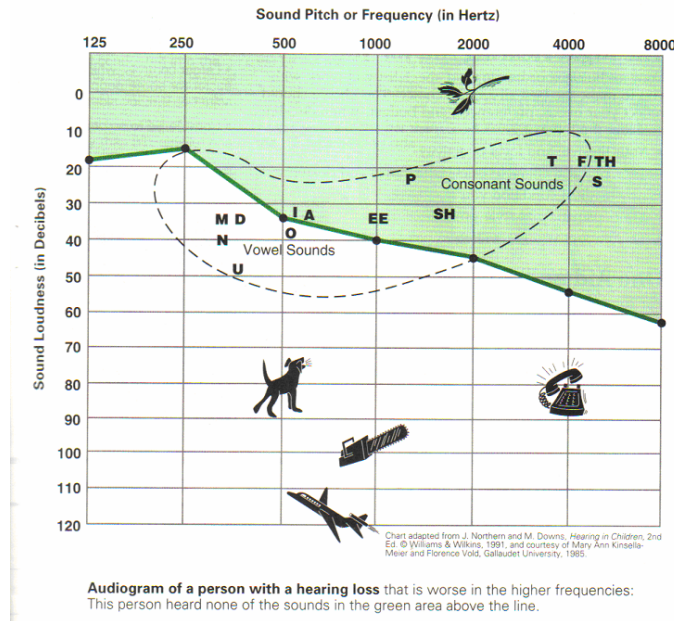

Fig. 1 Audiogram of missing consonant frequencies (Krame)

The most common type of hearing loss is sensorineural. About 90 percent of individuals who are hearing impaired have sensorineural hearing loss. This condition consists of either damage to the inner ear or damage to the nerves which transmit the messages from the ear to the brain. It is also known as nerve deafness. This condition is caused by disease, birth injury, or even aging. The most common form of sensorineural hearing loss is High frequency hearing loss. This is where an individual loses their ability to hear certain high frequency constants such as Sh, S, T, Th, P, or F sounds, as seen in figure 1. It is usually a loss of sounds above 1000 Hz but varies from person to person. This condition is not easily medically fixed. Most elderly Americans suffer from some form of high or low frequency hearing loss, along with 14.9 percent of children (ASHA, 1997-2006).

Hearing aids do not do an adequate job of revoicing this problem because they only amplify the sound. Consider a piano with no strings. No matter how hard the keys are hit, there is still not going to be any sound. Similarly, no matter how loud the hearing aid makes the sound, a person with high frequency hearing loss cannot hear sounds in those frequencies. Obviously, something more than hearing aids needs to be considered in order to help rising number of people with high frequency hearing loss.

The most common type of hearing loss is sensorineural. About 90 percent of individuals who are hearing impaired have sensorineural hearing loss. This condition consists of either damage to the inner ear or damage to the nerves which transmit the messages from the ear to the brain. It is also known as nerve deafness. This condition is caused by disease, birth injury, or even aging. The most common

Hearing Aids

Digital hearing aids are a more sophisticated version of the previous analog hearing aids. Analog hearing aids would only amplify the sound input, digital hearing aids are actually able to selectively filter and process the sound. They take the analog acoustic wave input and convert it to a digital signal for processing. The hearing aid can be customized by an audiologist to fit the needs of the specific user. They have multiple programs that can be implemented and customized including digital gain processing, feedback reduction, noise reduction, and speech enhancement. Gain processing allows for increased audibility of sounds of interest without discomfort caused by high intensity background sounds. Digital feedback reduction helps the hearing aid to recognize occasional feedback and eliminate it. Digital noise reduction reduces the level of steady noise which can help to increase comprehension of speech. Digital speech enhancement recognizes some speech based on temporal or spectral content and amplifies it relative to other sounds (Ricketts, 2005).

Most hearing aids work in a range of about 100 – 7000 Hz, which corresponds to the frequencies of speech. They can last for 5-10 years if they are kept clean and away from water and dirt. Digital hearing aids run mostly on size 13 or 312 batteries which need to be replaced about once a week, but this depends on how much of the time they are actually processing sound (Product Information). The cost of digital hearing aids runs between \$1500 and \$5000 for one hearing aid.

There are two main types of hearing aids, behind the ear (BTE) and in the ear (ITE). The behind the ear models have the microphones and the processor behind the ear and rubber tubing that leads from the processor to the piece in the ear. There are three different ITE models, in the ear, which covers the whole inner part of the ear, in the canal, which occupies the whole canal,

and completely in the canal, which is completely in the canal and cannot easily be seen. Each of these types has their advantages and disadvantages. The ITE models are not recommended for children or people with severe hearing loss and can be damaged by conditions in the ear such as earwax. The BTE models are suitable for all ages, have manual volume control, and are used for all types of hearing loss (Hearing Aids, 2000).

Existing Sensory Substitution Products

The existing devices, however, are made specifically for people with complete hearing loss. For example, the Tickle Talker™ uses vibro tactile stimulation on the fingers of the user. Each finger receives stimulation from a different range of frequency and based on the pattern, strength, and duration of the vibration, the user can pick out a certain frequency range. Since this form of sensory substitution covers the whole spectrum of hearing, it is not sensible for a person with only high frequency hearing loss to use the device. They would have to sift through way too much information to get the signals they needed. With such a large learning curve, the user must spend hours with the device to learn minimal amounts of words. For example, after more than 40 hours of training, a certain user could only identify 70 words (Galvin, 1999). The high frequency user could adapt at a much faster rate to only a high frequency stimulator because they are only missing certain sounds, not the entire spectrum.

Other similar devices include the Tacticon 1600 and the Tactaid VII. The Tacticon 1600 uses electro stimulation by putting electrodes on a belt around the user's abdomen (Lynch, 1992). This

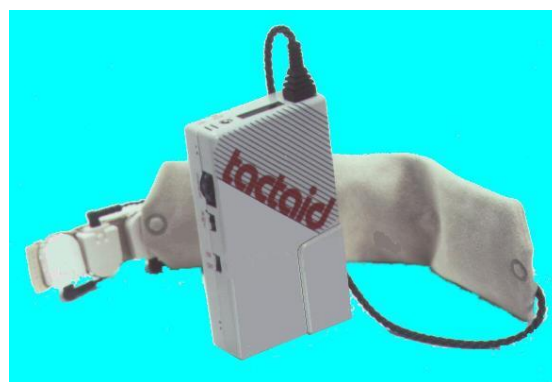

Fig 2. Tactaid VII (Audiological Engineering Corp)

device also covers the whole spectrum of hearing and has a steep learning curve. In similar ways, The Tactaid VII, seen in figure 2, uses vibrations covering the entire range of human hearing (Lynch, 1992). The vibrators are attached to the user's sternum, each corresponding to a certain frequency range.

System Diagram

There are three major components of design in this project, obtaining an acoustic signal, the sound processing unit which filters and divides the signal, and the array of electrodes. The first two parts will remain the same throughout the alternative designs and the proposed design. Recordings will be taken of full sentences as well as word pairs. The acoustic audio waves will be sent to a microphone and converted into an analog voltage signal, which will then be sent to a sound card. The sound card will convert the information to a digital signal and pass that information along to a computer. That information will then be filtered, using sound editing software, into four channels that represent regions of sound information that is missed by people with high frequency hearing loss. Then the computer will output the digital signal back to the sound card which will output the information to an amplifier and then finally to transducers. The systems diagram can be seen in Appendix 3. The third part, the transducers, is the part that will vary for the alternate designs.

Tactile Stimulation

The device will contain several transducers that will convert the electrical signal coming from the sound processing unit into a tactile sensation that notifies the user of the missing high frequency auditory information. Several patterns for the tactile stimulation were considered,

including an array of transducers which would use Morse code or spatially map letters on the user's skin. However, after deciding not to focus on alerting the user of specific letters and instead alert them of raw frequency and amplitude of high frequency sounds we needed a new pattern for communicating the information. We decided to use a series of several electrodes, lined up vertically, which will each correspond to a specific frequency and will discharge after that frequency is picked up by the hearing aid and the signal passed through the sound processing unit. The two types of transducers considered were electrotactile and vibrotactile transducers.

Electrotactile Transducers

Electrotactile transducers create tactile sensation by passing a small amount of current, normally from 1 – 20 mA, through the skin. In order to generate this current a voltage of between 200 and 500 V is necessary (Kaczmarek, 1991). Typical electrodes consist of gold or silver plated discs a few millimeters in diameter.

One of the key advantages to using electrodes is their relatively low power consumption. A 3 mm electrode uses 1.2 mW of power, which is approximately an order of magnitude

lower than that of a similarly sized vibrotactile transducer

(Kaczmarek, 1991). Electrotactile transducers are also

advantageous because their relatively easy construction. A simple electrode consists of a piece of conductive metal that is attached to a current source. Because of this, it is also relatively easy to make them very small, which is key when trying to fit several into a limited space.

However, this style of transducer also suffers from several minor problems. The electrode requires strong, even contact with the skin and benefits from a conductive medium at



Fig 3. Ag-AgCl EMG Electrode

the electrode to skin interface. If good contact is not maintained between the skin and the electrode larger amounts of current can pass through a smaller area of skin, causing minor burns or shock. However, this is usually only a problem when dealing with much larger currents, values around 160 mA (Kaczmarek, 1991). Another problem that stems from poor contact with the skin is the variation in both magnitude and quality of the sensation that a person can feel from day to day, which is also partially due to the dryness of the skin, amount of perspiration being generated, and location of the electrode array on the body.

Vibrotactile transducers create tactile sensation by vibrating at a set frequency and waveform. They can comfortably depress the skin up to 0.5 mm for a 1 mm diameter stimulator. A typical type of vibrotactile transducer is the piezoelectric transducer. The piezoelectric transducer, as seen in figure 4, operates by changing the voltages of its faces which cause molecules of its crystalline structure to realign back and forth with the changing voltage and thus results in vibration (NDT).

A few of the advantages of the vibrotactile design are that the user experiences less variation in the sensation and it is often described as being more comfortable. Because the transducer is only depressing the skin and not sending current through it, the sensation is less dependent on the day to day variations in the skin's properties. Consequently, vibrotactile stimulators are often described as being more comfortable than their electrotactile counterparts.

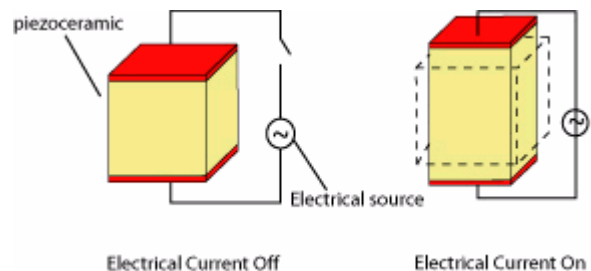

Fig 4. Piezoelectric transducer

The major disadvantage of vibrotactile transducers is their high power consumption, 168 mW for a 4 mm stimulator (Kaczmarek). This is more than ten times higher than that for a similarly sized electrotactile stimulator. Because the final device is to be portable and battery operated, keeping the power consumption of the transducers low is a key design consideration. Vibrotactile transducers, such as the previously mentioned piezoelectric transducers are also much more complex to construct, requiring voltage plates attached to either side of a ceramic piezoelectric material.

Placement

As for the placement of the tactile stimulation, three areas, inside the ear (ITE), behind the ear (BTE), and the back of the neck, were considered. All of the considered areas were on the head in order to allow for both easier integration with the user's hearing aid and the least conspicuous placement. Also considered in the decision for placement was the two-point minimum spatial discrimination threshold for electro and vibrotactile stimulation. Common values for this threshold are between 7.25 and 10.23 mm, normally decreasing as one nears extremities such as the hands (Solomonow, 1977).

The key advantage for placement of the transducers in the ear is that it allows for almost complete concealment of the tactile element of the device. However, because the device is being placed in such a small area the construction would be much more complicated than for the other areas. Also, with multiple stimulators, it would be difficult to space the stimulators far enough apart to reach the two-point discrimination threshold. Another disadvantage to this placement would be the adverse conditions of the inner ear, which might cause damage to the device due to build up of ear wax or moisture.

Placement of the transducers behind the ear allows for the device to be mostly concealed from outsiders. This design also results in the easiest access to the user's hearing aid. Another advantage is that if vibrotactile stimulation is used, bone conduction would help with propagation of the signal. One of the few disadvantages of this placement is that its attachment may be impeded by the hair of the user.

The final area considered for placement of the transducers was on the back of the neck. This area allows for the most space for the tactile layout, which would help in surpassing the two point minimum discrimination distances. This large amount of space also would allow for the easiest construction of the transducer layout. However, placement on the neck allows for the most visibility to outsiders, which is a major drawback to the designs aesthetics.

Alternate Designs

Between the vibro- versus electro-tactile stimulation and the three placement options, this project has the possibilities of six different designs. Both designs that involve the in the ear placement were eliminated due to the complexity involved with a smaller area for placement. The other option eliminated was vibro-tactile placed on the neck. The neck bone conductivity is far lower than that of behind the ear.

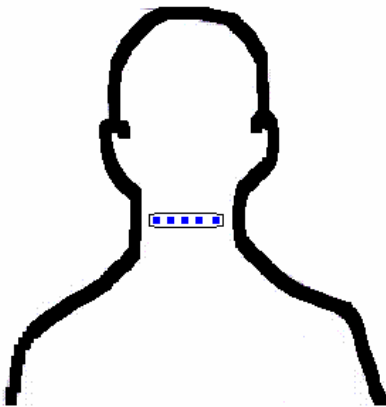

Fig 5: Electro-neck design

The first alternative design is electro-tactile placed on the neck as seen in figure 5. The electro portion of this design would allow for the stimulators to be smaller and draw less power. The drawback to this design, the reason that it was not chosen was aesthetics. The goal of current hearing aid designs is to lessen their visibility to outside

world. To go along with the trends of those hearing aids, accessories, like this design, should continue to be less visible.

The second alternative design is vibro-tactile placed behind the ear as seen in figure 6. Due to the mastoid process the bone conductivity of this location is ideal for stimulating the user. The location allows the user to better hide the device from the public eye. There are a few drawbacks to this design. First is that it is vibro-tactile and therefore will draw more power. The second drawback and biggest concern is that the user will not be able to differentiate between whether one stimulus is firing or two stimuli are firing. Without proper differentiation, the device does not fulfill its intended purpose which is to allow the user to determine frequency with tactile stimulation.

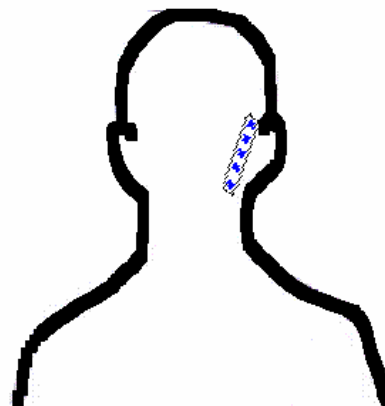

Fig 6: Vibro-behind the ear design

Proposed Design

The proposed design is electro-tactile placed behind the ear. It is the most aesthetically appealing of our designs because of location as well as the electro-stimulators will be smaller than the vibro-stimulators. Since it is electro-tactile it will draw a smaller amount of power, as well as the electro-stimulation will be more easily differentiated. The user will be able to determine how many electrodes are firing at any one time.

The electrodes will be arranged in an array placed along the curve of the ear. They will be attached as one unit instead of separately. This serves two purposes. It allows the user to be able to attach all electrodes at one time, which makes it easier and more likely that they will wear it on a regular basis. The array can be seen in figure 7. It also allows for correct placement of

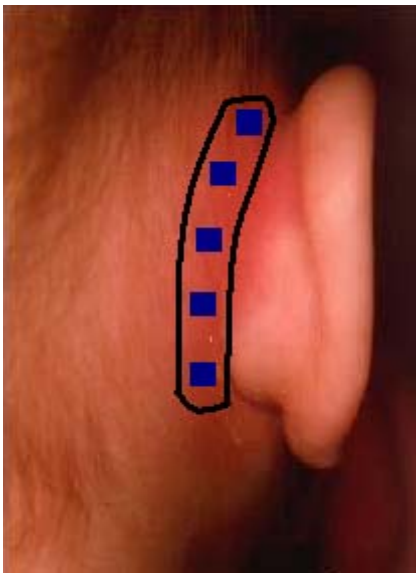

Fig 7. Behind the ear vibro-tactile array

the electrodes in order to ensure that the distance is enough to allow for differentiation. If attached separately, the required work for the user would be too difficult.

Each electrode of the array will correspond to a certain range of frequency, which will be dependent on the need of the user. Dependent upon the frequency bandwidth

of the incoming consonant, that will signal the amount of electrodes stimulating the user. It works like a volume

control, as the volume increases the number of bars shown increase. For the device being designed, as the frequency range increases the number of electrodes stimulated increase.

Final Design

Due to some unforeseen difficulties, after the mid-semester presentation it was necessary to make a few changes to the proposed design. After discussion with Dr. Heide, the advising client, it was decided that using computer software to edit the sound waves would be the main component of sound processing. Using software as opposed to building a band-pass filter allows for greater flexibility when testing which frequency ranges are most helpful to the end user. The proposed electro-tactile design required circuitry to drive the electrodes that would be too sophisticated to build in one semester. Also, because a local supplier of vibro-tactile transducers was found, the output design was switched to vibro-tactile.

Cool Edit

Once the sound is recorded to the computer hard drive, it is edited in Syntrillium Software's Cool Edit Pro version 2.1. The raw recorded file is first filtered to reduce the amount of background noise. This is performed by selecting a portion of the file that is pure noise, uploading it as the noise profile, and then eliminating this portion of sound from the file. After noise reduction, the sound file is edited into four different frequency bands, 1.6 – 2 kHz, 2 – 3 kHz, 3 – 3.5 kHz, and 4.5 – 8 kHz. In order to do this the original noise reduced sound file is run through a simple FFT filter that reduces any sound outside of the selected frequency range to 0 dB and amplifies the sound in the frequency range five times. Each time the original file is run through the FFT filter, the outputted file is saved separately as a track number. Now, each track is selected to either be output to a left mono or right mono output. In order to have as little sound as possible come out of the left channel for a track that is to be outputted to a right channel, the tracks are panned to the appropriate side. Once all four tracks have been noise reduced, FFT filtered, and panned, they are dragged to four different output channels in the Multi-channel Encoder sub-menu and the final output is saved as a .wma file. This final output file can then be played in media player and is encoded to output each frequency subdivision of sound to a specific channel of the audio output.

Soundcard

The audio output device in use is the Turtle Beach Audio Advantage Roadie external soundcard, as seen in Figure 8. The soundcard allows for 5.1 channel surround sound, thereby having a total of 6 channels for outputting



Fig 8. Turtle Beach Audio Advantage Roadie

sound. The Roadie has a maximum output level of 1 – 2 V for each output channel. The voltage levels outputted from this device for the .wma files from the computer are at a level between 0 mV and 50 mV, too small to drive the desired vibro transducers. Therefore, an amplifying circuit is necessary to step up the supplied voltage to the transducers.

Circuit

The circuit is comprised of four dual comparators in conjunction with 10 k Ω and 1k Ω resistors. The circuit first amplifies the signal coming from the sound card, which ranges from 0-50 mV, and then sends the signal to the comparator which filters out any part of the signal which is below the specified amplitude level. The output from the comparator is then sent to one of

four corresponding transducers where it drives the piezoelectric vibration. The circuit is powered by two 9V batteries. The configuration of the circuit can be seen in Figure 9.

The amplification portion of the circuit works by comparing the resistors and amplifying the signal from the sound card by a simple non-inverting amplifier, with a gain of $(R1+R2)/R1$. In this case R1 is 1 k Ω and R2 is 10 k Ω so the amplification is eleven. The 1k Ω resistor is attached to the positive input and the positive 9V power source. The 10 k Ω resistor is connected to the positive input and the output. The input

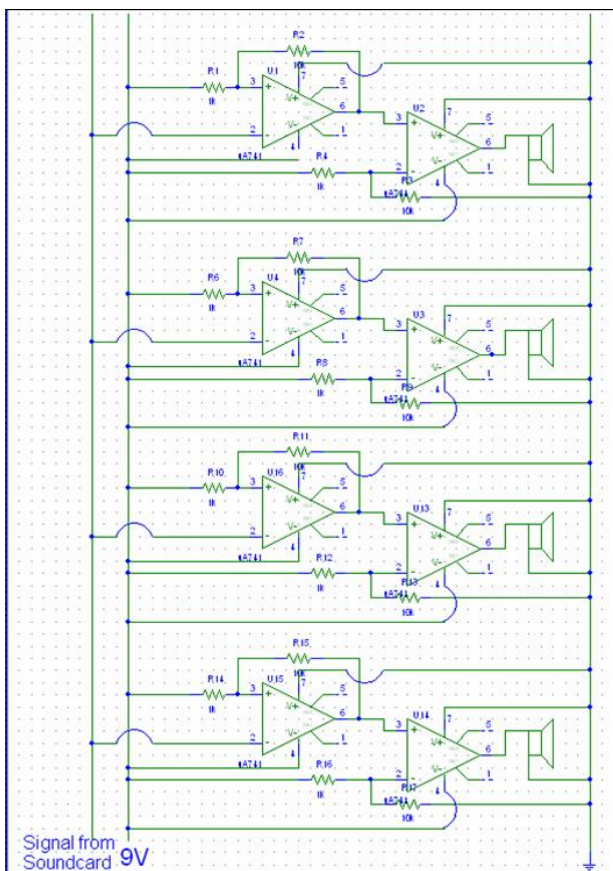

Fig 9. Circuit Diagram

from the sound card is into the negative input of the comparator.

The output from the amplification portion of the circuit is then sent to the input of the comparing part of the circuit. This portion of the circuit also consists of one 1 k Ω and one 10 k Ω resistor. The 1 k Ω resistor is connected to the positive 9V and the negative input and the 10 k Ω resistor is connected to the negative input and ground. The voltage of the input from the amplifier is compared to a ratio of the two resistors and the power to the comparator. Since the power to the comparator is 9V and the resistors used are 1 k Ω and 10 k Ω , the ratio is 1 to 10, and any signal below .9V is not considered important to the output and is grounded. Any voltage above .9V closes the circuit and a signal is transmitted to the transducers. The output from the comparator is an all or nothing signal, which means that if the circuit is activated by a voltage above .9 V, it will transmit at a constant level until the input signal goes below .9 V and the signal is grounded.

Transducers

The final design was originally intended to employ vibro-tactile transducers obtained from the local company Orbitec. These are two channel transducers which are sensitive to both the frequency and amplitude of the supplied signal. However, because of the relatively small amount of time Orbitec was given to find and test these transducers it was not possible to acquire them for the project this semester. The piezoelectric buzzing transducer is used as a replacement for these vibro-tactile transducers because of their similar two channel sensitivity. The signal driving these transducers comes directly from the aforementioned circuit and produces a middling frequency buzzing sound. These buzzing sounds are caused by rapid vibrations in the

piezoelectric material, which provide a similar idea as to how the circuit would drive Orbitec's vibro-tactile transducers.

Output

Since high frequency consonants cannot be heard by individuals with high frequency

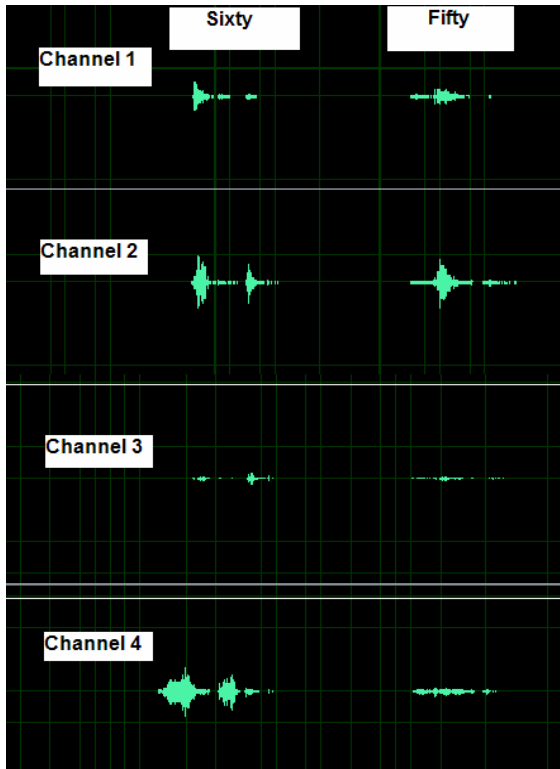

Fig 10. The vibrations in each channel for the words fifty and sixty

cause transducer 4, the transducer for the highest frequencies, to fire, while the 'f' sound of fifty causes only transducer 2 to fire. This is shown in Figure 10. Thus, the user can determine which word is being said by which transducer fires. In

hearing loss, there are many words pairs that are indistinguishable. For example, the words 'fifty' and 'sixty' both contain high frequency consonants (the 's' and 'f' sounds) which make these two words unidentifiable. Using this device, the words fifty and sixty are tactilely distinguishable. The 's' and 'x' sounds of sixty

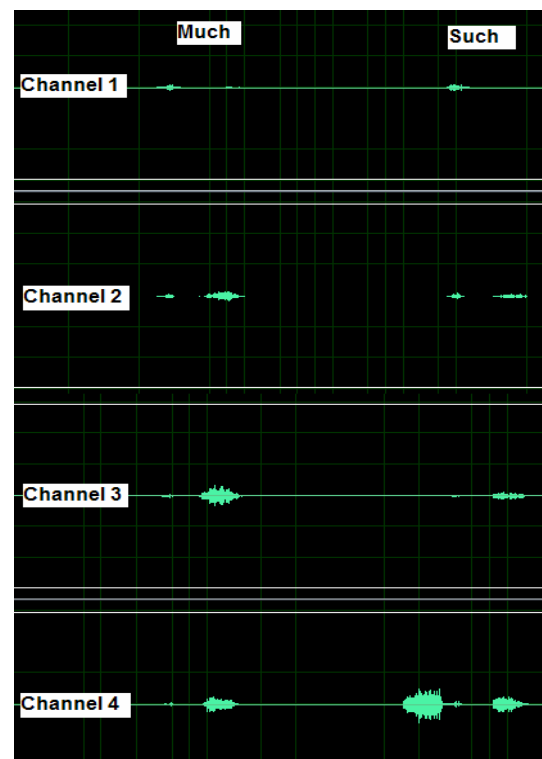

Fig 11. The vibrations in each channel for the words much and such.

general, 's' sounds can be associated with channel 4 and 'f' sounds with channels 2 or 3.

Another example of word discrimination explored in this project is between the words 'such' and 'much'. Since individuals with high frequency hearing loss cannot hear the 's' or 'ch' sounds, each word sounds the same. As can be seen in Figure 11, the words much and such are successfully separated. The 'm' sound from 'much' causes only transducer 1 to fire while the 's' sound from 'such' causes only transducer 4 to fire. Since the 'ch' sound is very powerful, however, it causes each transducer to fire, but because of the 's' sound, the user can identify which word is 'such' and which is 'much'. Other troublesome word pairs that were distinguishable using this system include 'church' and 'shirt' as well as 'sob' and 'shop'.

Future Work

First and foremost, the vibro-transducers need to be obtained from Orbitec. There was not enough time this semester for Orbitec to test their product, small, dual solenoid vibro-transducers, before donating them to the project. The transducers will be attached together as a unit and Bioflex® adhesive, produced by Scapa North America, will be used to attach the device to the user. Bioflex® is a silicone polymer gel adhesive that is applied in a single layer to a co-polyester fabric liner. The adhesive is water resistant, easily removable and repositionable. It can be washed with water, and when properly dried, it regains its adhesive properties. Bioflex® has also undergone and passed skin irritation tests. The vibrotactile transducers will be set in the gel adhesive, so the user will be able to easily place the device behind the ear. The transducers will be removable from the adhesive so that it can be washed and dried (Scapa, 2006).

After obtaining the vibro-transducers, the next step is to decrease the size of the project as a whole. This will mean size reductions of two main components of the system. First, the circuit

would be soldered onto a smaller board. Second the computer would be eliminated by putting the system into real time. These two size reductions would allow for the user to wear the device. Before the final design can be implemented, a final decisions needs to be made regarding the ranges for each channel. Currently each channel covers a range of multiple letters; more channels will be added to allow for more specific divisions i.e. per letter. Once the system is in its final design, it will be tested on people with high frequency hearing loss. This will be done to determine the effectiveness of vibrations substituted for sound.

References

- American Speech-Language Hearing Association (ASHA). The Prevalence and Incidence of Hearing Loss in Children. 1997-2006. Date Visited: 10/17/2006.
<http://www.asha.org/public/hearing/disorders/children.htm>
- Audiological Engineering Corp. (n.d.) Tactaid 7. Retrieved 29 September, 2006 from
<http://www.tactaid.com/tactaid71.html>.
- Better Hearing Institute (BHI). Hearing Loss- The Prevalence of Hearing Loss. 2005-2006. Date Vistied: 10/13/2006.
http://www.betterhearing.org/hearing_loss/prevalence.cfm
- Galvin, K. et al (Aug 1999). Acquisition of a tactile-alone vocabulary by normally hearing users of the Tickle Talker™. *The Journal of the Acoustical Society of America*, Vol. 106, Issue 2, pp. 1084-1089.
- Hearing Aids. (2000). *Hearing Planet*. Retrieved September 21, 2006, from
<http://hearingaidhelp.com/hearingaids.html>
- Kaczmarek, K. A., Webster, J. G., Bach-y-Rita, P. and Tompkins, W. J. Electrotactile and vibrotactile displays for sensory substitution systems 1991.
- Krames Communications. (1995). Hearing Aids. [Brochure]. San Bruno, CA.
- Lynch, M., Eilers, R., (April 1992). Open Set Word Identification by an Adult with Profound Hearing Impairments: Integration of Touch, Aided Hearing, and Speech Reading. *Journal of Speech & Hearing Research*, April 1, 1992, Vol. 35, Issue 2.
- “Piezoelectric Transducers.” NDT Resource Center. 19 October 2006 <http://ed.org/EducationResources/CommunityCollege/Ultrasonics/EquipmentTrans/piezotransducers.htm>.

- Product Information Eleva & microEleva. *Phonak*. Retrieved September 21, 2006, from,
[http://www.phonak-us.com/ccus/professional/products_us/instruments_us/
us_professional_products_instruments_digital/elevap/elevaoverview_p.htm?activetab=29
597](http://www.phonak-us.com/ccus/professional/products_us/instruments_us/us_professional_products_instruments_digital/elevap/elevaoverview_p.htm?activetab=29597)
- Ricketts, T.A. (2005). Digital Hearing Aids: Current “State-of-the-Art”. *American Speech-
Language-Hearing Association*. Retrieved September 21, 2006, from
http://www.asha.org/public/hearing/treatment/digital_aid.htm
- Scapa. (2006). *Bioflex*. Retrieved 31 November, 2006, from
<http://www.scapana.com/productdetail.jsp?productid=3637&search=products>
- Solomonow, M., Lyman, J. and Freedy, A. Electrotactile two-point discrimination as a
function of frequency, body site, laterality, and stimulation codes 1977.

APPENDIX 1: Project Design Specifications

Function:

The goal is to design and develop an auditory substitution device that through the use of a digital hearing aid and vibro- or electro-tactile stimulation can substitute for regional frequency hearing loss.

Client Requirements:

- High frequency hearing loss is the most common form of hearing loss experienced, which is caused by damaged nerve ends on the hairs in the cochlea and cannot be fixed with amplification of these high frequency consonants. Instead of amplification, these missing consonants can be communicated by sensory substitution.
- The device will allow the user to distinguish one sound from another which they are not able to do with auditory information alone.
- The substitution prototype will use vibro- or electro-tactile stimulation.
- The device should be self contained.
- The device should be able to be adjusted for the needs of the individual user's hearing loss.
- The device should be able to work with existing digital hearing aids in order to avoid the user needing separate devices.

Design Requirements:

1. Physical and operational characteristics

a. Performance requirements:

- When in use, the device will need to be functioning continuously and accurately.
- It will increase the user's quality of communication by allowing the user to recognize high frequency consonants and incorporate them into word recognition through tactile stimulation.
- It will also recognize and alert the user to high frequency alarms.
- This device should use programmable functions of a digital signal processing hearing aid to recognize certain high frequency sounds and communicate them to the tactile stimulator.

b. Safety:

- This device will be used in or near to the ear. Therefore current of more than 5 mA should not pass through the device and into the user.
- The device should not heat to over 110° F while in use.

c. *Accuracy and Reliability*: The device should be accurate enough to process and substitute for the consonants T, F, S, Th, Sh, and P when coming from a variety of different vocal tones encountered in daily usage.

Human Hearing Frequency Range: 20 – 20,000 Hz

Speech Frequency Range: 125 – 8,000 Hz

High Frequency Hearing Loss: above 1,000 Hz

Sound	Approx. Frequency in Hertz
T	3500
F	4000
S	4000
Th	4000
Sh	2000
P	1500

*Most of these sounds are around 4000 Hz. This is the frequency most commonly damaged by loud noise and toxins.

* “S” sound is the most common sound in the English language. It is also the softest and highest frequency.

d. *Life in Service:*

- The device should have a service life comparable to that of a digital hearing aid, approximately 5 – 7 years.
- On a single battery charge the device should last approximately 5 days, similar to that of a common hearing aid so they can be charged at the same time.
- Common hearing aid batteries have an output voltage of 1.4 V and have power ratings between 140 and 640 mAh. With daily use of the device being about 14 hours the device should draw from 2 - 10 mA of current from the battery.

f. *Operating Environment:*

- The device will be located around or in the ear.
- If inside the ear (ITE) the device should not be adversely affected by earwax.
- If it is behind the ear (BTE) elements such as wind, rain, sun and sweat should not cause the device to vibrate for non-spoken noises, output dangerous levels of current or distort outgoing signals.

g. *Ergonomics:*

- The device should fit snugly in or behind the ear.
- The device should not move during normal physical activity.

h. *Size:*

- A BTE unit should be less than 5 cm in length, 1.75 cm wide and 1.25 cm thick so the unit can be completely covered by the ear.
- An ITE unit should be approximately 1.2 cm x .9 cm x .9 cm (approx. the size of an ITE hearing aid) to allow for easy access to insert and remove it.

i. *Weight:*

- The weight for the ITE device should be no more than 1.5g and the BTE unit should be no more than 5 g (similar to that of common digital hearing aids).

j. *Materials:*

- Soft, durable plastic such as vinyl

- Adhesive to hold the BTE unit in place should not irritate skin, leave large amounts of residue, or be painful to remove.

k. *Aesthetics, Appearance, and Finish:*

- Unit should be flesh-colored and not overtly noticeable to others.
- Adhesive attachment used for BTE unit should not leave large amounts of residue and should not be painful to remove.

2. Production Characteristics

a. *Quantity:* If able to plug into the users existing hearing aid, the device should be able to be produced in mass quantities.

b. *Target Product Cost:* The device should cost between 5-10% of the total cost of the hearing aid.

3. Miscellaneous

a. Standards and Specifications: FDA approval

b. Customer: May have preference for devices that are ITE or BTE

c. Patient-related concerns: Device should not cause discomfort due to tactile or electro-tactile stimulation or adhesive and should not be overtly noticeable. It should also be easy to use i.e. just require the user to put it in place.

d. Competition: Tactaid 7 <http://www.tactaid.com/tactaid71.html>

Tickle Talker

Tacticon 1600

APPENDIX 2: Design Matrix

	Electro-Neck	Vibro-Ear	Electro-Ear
Power Consumption (out of 10)	10	5	10
Safety (out of 5)	4	5	4
Ease of Manufacturing (out of 5)	4	2	4
Patient Comfort (out of 5)	3	4	4
Aesthetics (out of 10)	4	8	8
Total	25	24	30

APPENDIX 3: Systems Diagram

