

Abstract

Approximately 450,000 people are living with thyroid cancer today, and its prevalence has been increasing an average of 5% per year. In serious cases, radioactive iodine (I-131) may be employed as a final resort treatment for thyroid cancer to destroy any residual cancerous cells remaining after surgery. Radioactive iodine is ingested by the patient and concentrates itself among the thyroid cells, remaining active for four to six weeks. Due to the radioactive properties of I-131, radiation is emitted off the patient in the form of beta particles and gamma rays causing harm to healthy tissues of not only the patient but also individuals in their vicinity.

This design project seeks to create a device that assists recovering thyroid cancer patients. The device alerts the patient when he/she is within one meter of another human, therefore minimizing the potential danger to those in a radioactive zone. The device uses infrared and distance sensors to detect motion, and warns the user using vibration motor discs.

Fabrication

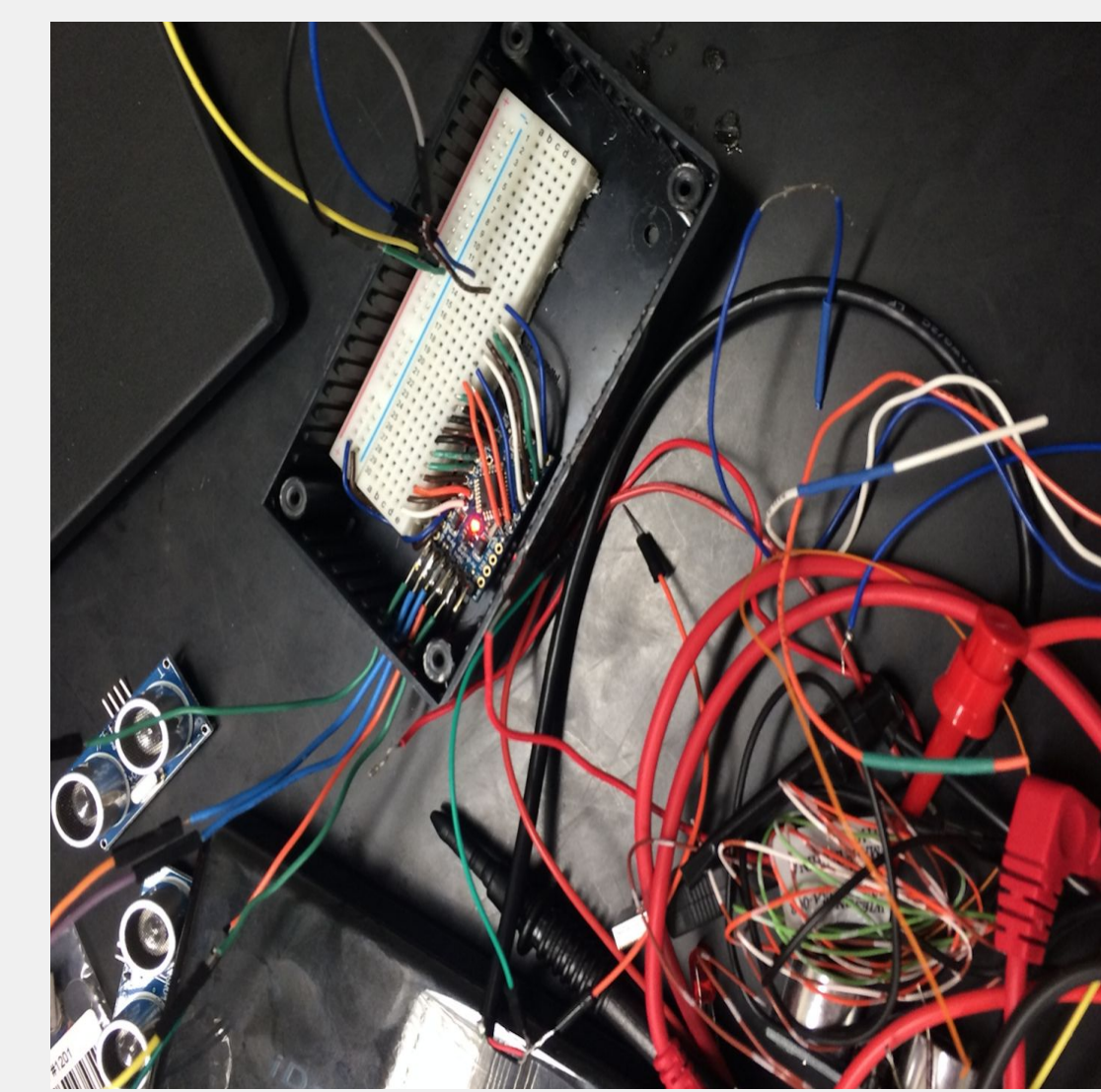
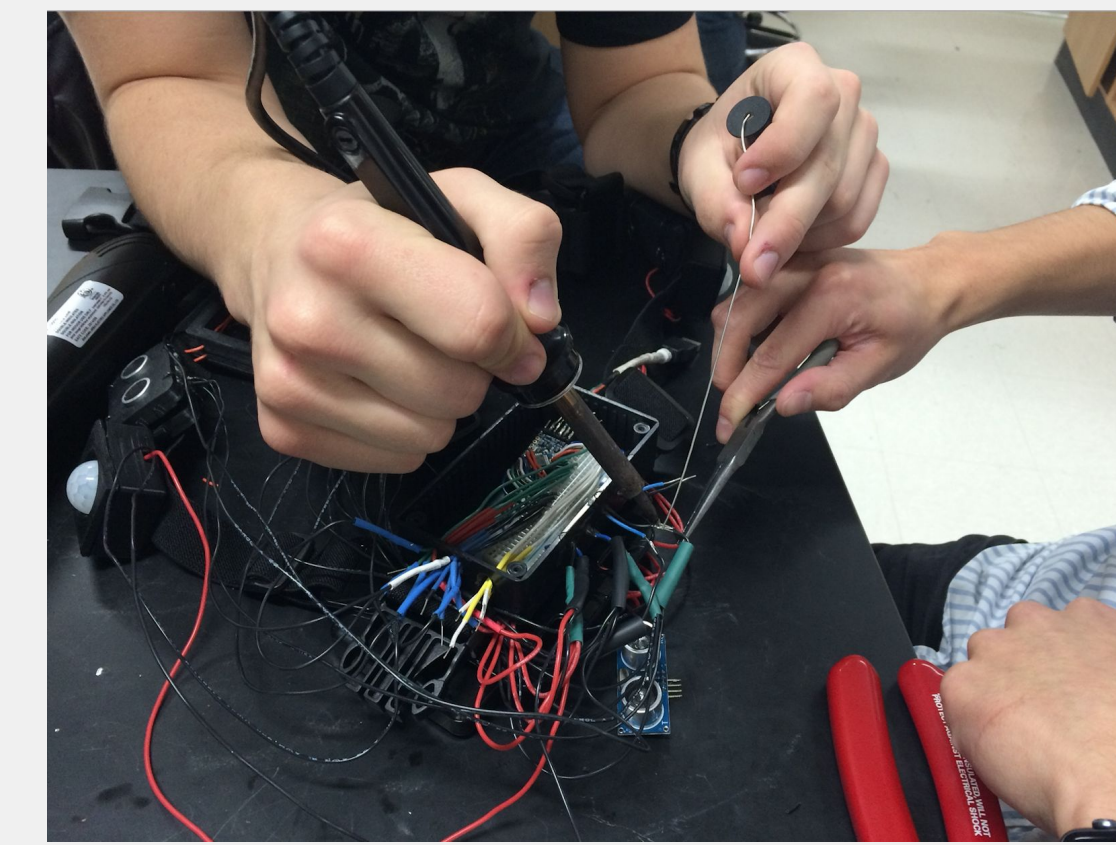
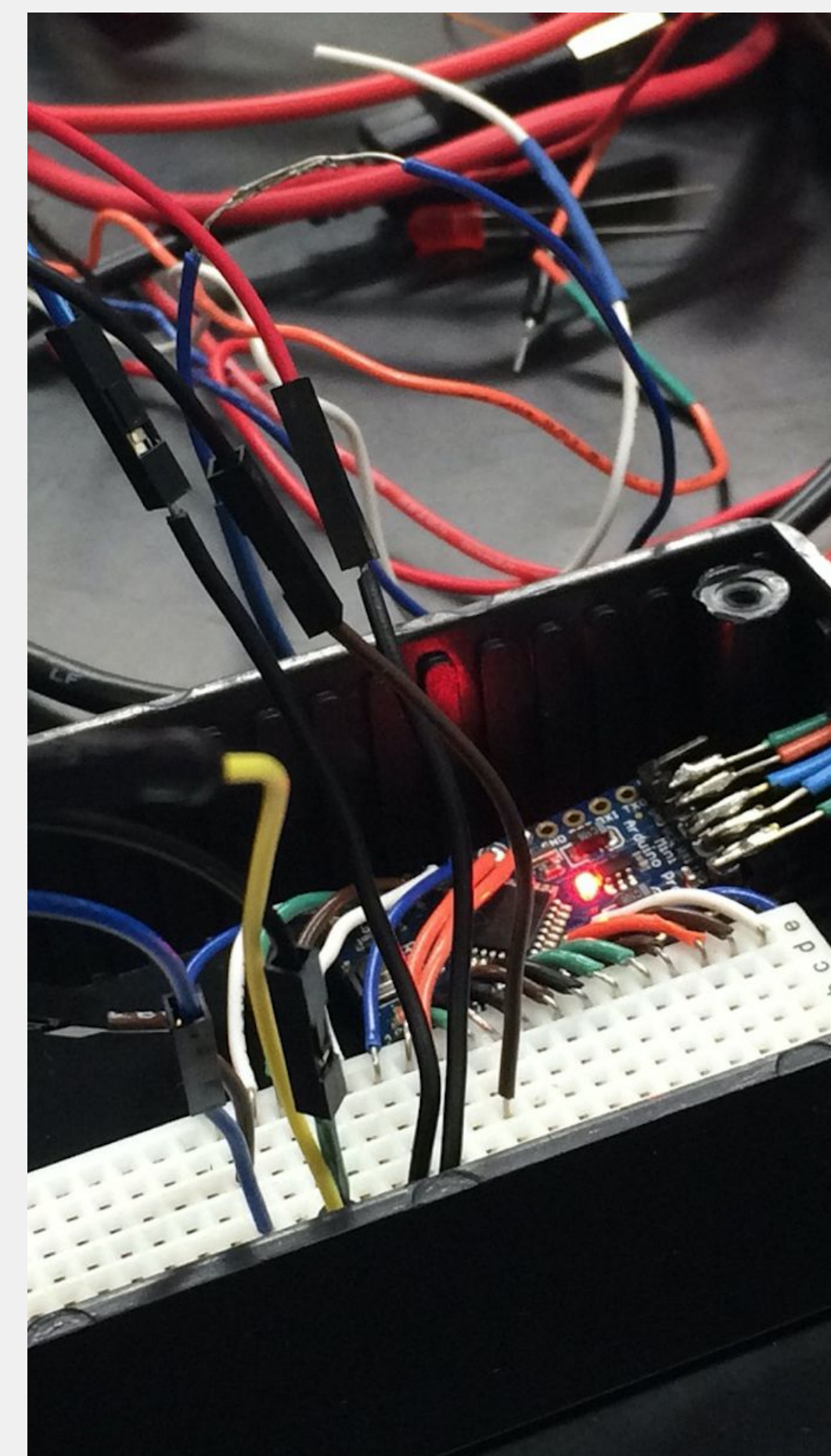

Testing & Results

Sensor Testing

The PIR sensor's field of view nearly matched the 110° cone in the data sheet and at minimum sensitivity they reliably caught movement within 3 meters.

The distance sensor accurately measured distance up to 200m, and was able to come as close as 2cm.

Feedback Delay Testing

The device was worn, and subjects walked into the 1-meter radius. A stopwatch recorded the time it took for the device to give feedback, averaging 3.74 seconds.

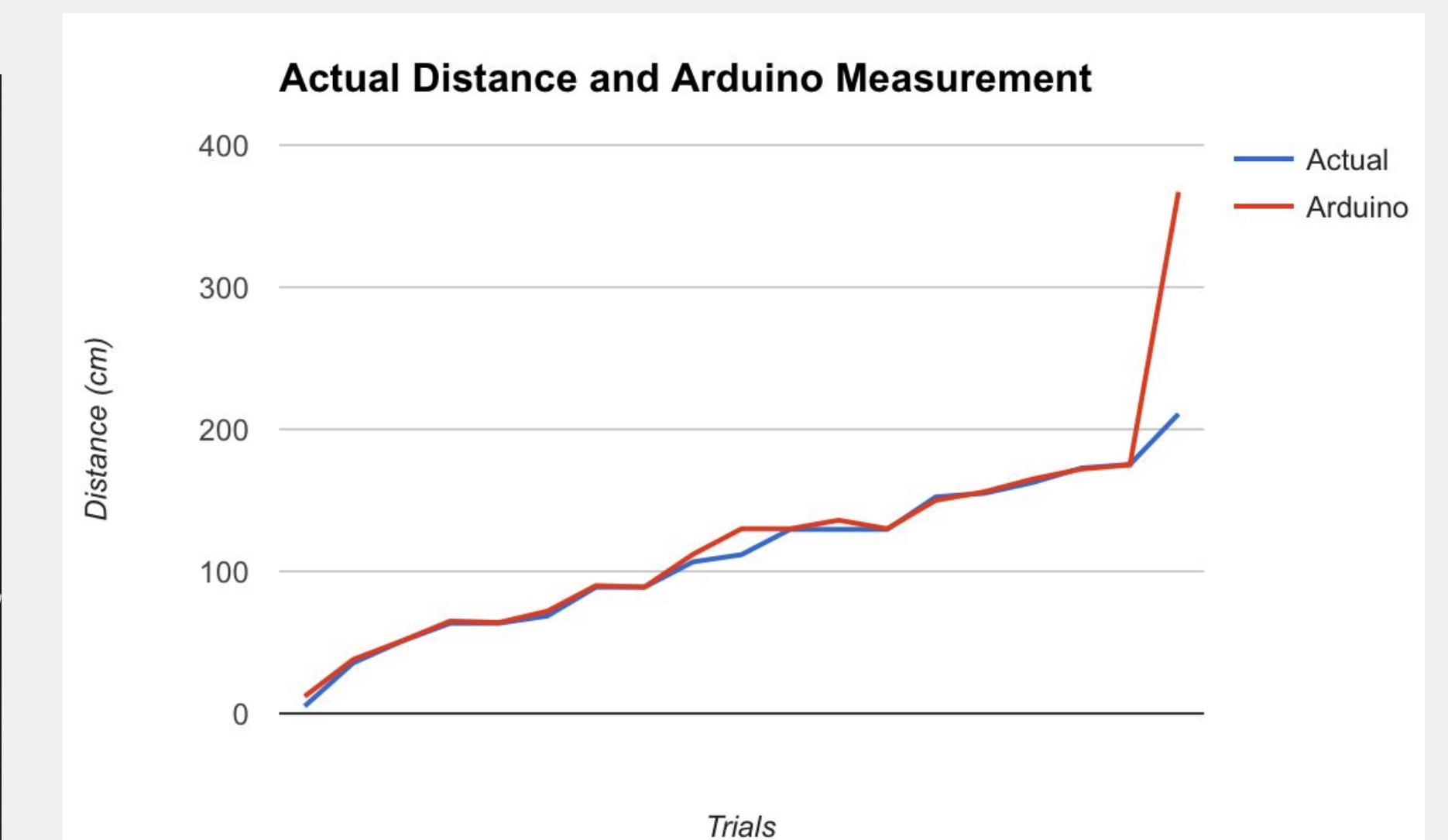
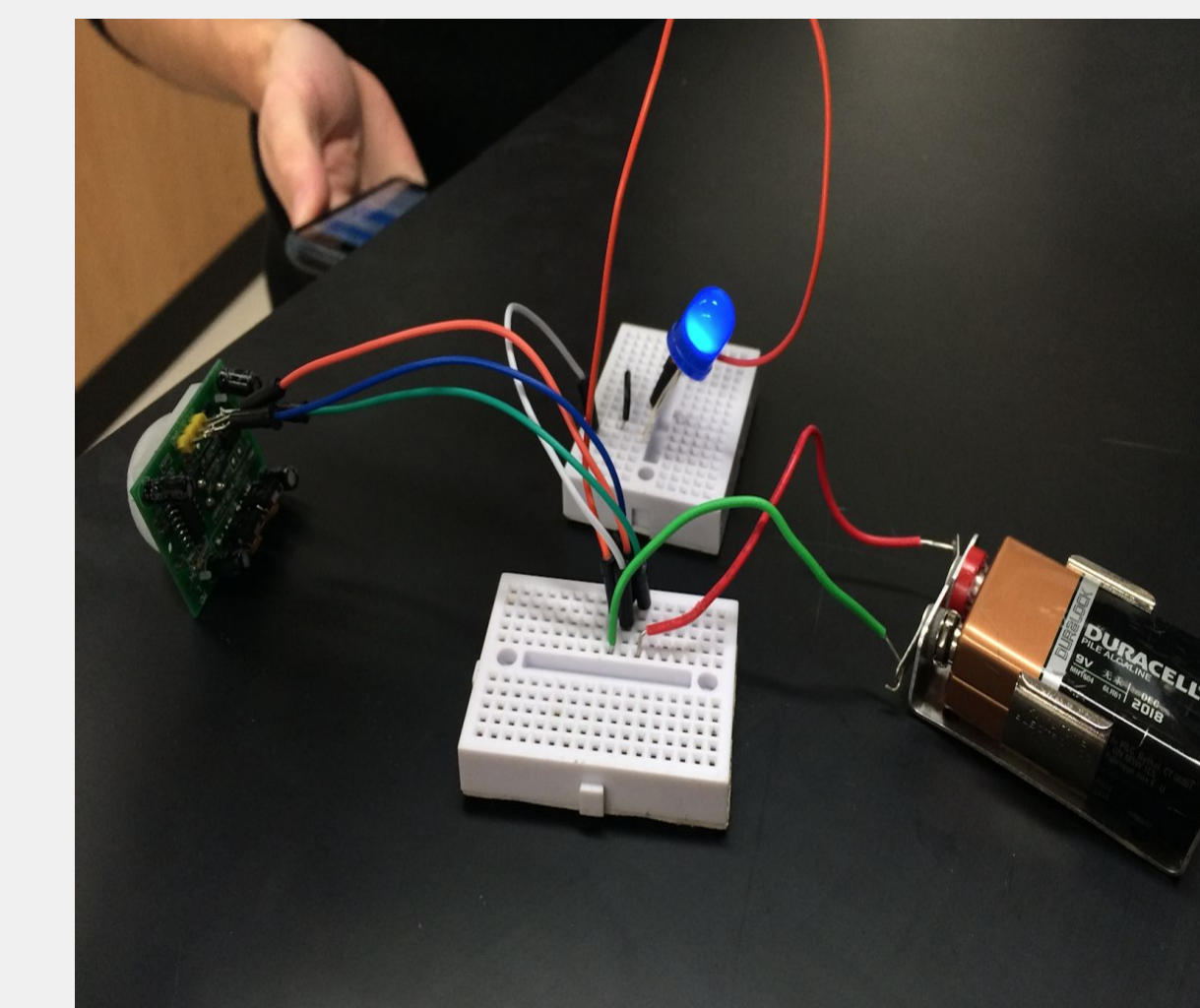

Introduction

Thyroid Gland:

- Located in the neck, surrounding the trachea
- Produces and distributes regulatory hormones

Thyroid Cancer:

- Increasing incidence in all areas of the world
- Causes difficulty speaking, swallowing, and breathing

Radioiodine: I-131

- Half-life of 8.01 days
- β particles travel 2mm, destroy malignant tissue
- Γ radiation travels 2m, poses threat to others

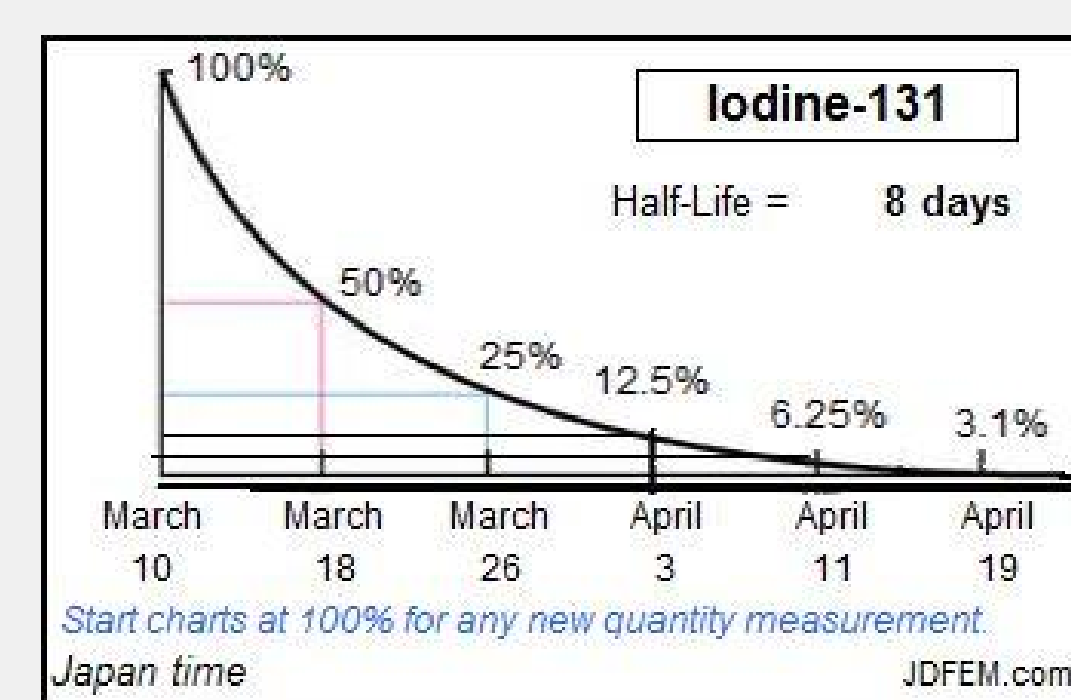
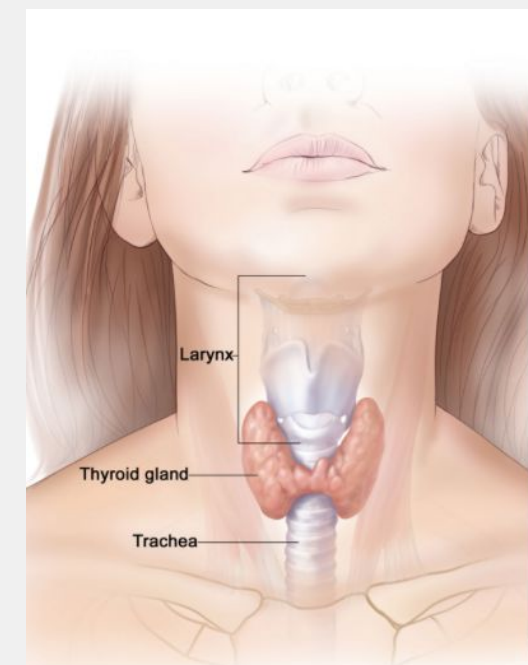

Figure 1: Thyroid gland¹

Figure 2: I-131 decay²

Design Requirements

- Detect a human from 15 to 100cm in front of the device and alert the wearer
- Full 360° as possible
- Must be comfortable and not interfere with regular movement.
- Must not harm the user
- Must last for the 6 week duration and have enough battery to last a full day

Final Design

Components:

- Six HC-SR501 Pyroelectric Infrared Sensors
- Six HC-SR04 Ultrasonic Distance Sensors
- SHINEDA® Chest Harness Mount for GoPro
- iDaye 14000 mAh External Battery
- Vibrating Mini Motor Disc
- Arduino Pro Mini
- Half of a Breadboard
- ABS 3D-printed sensor casings

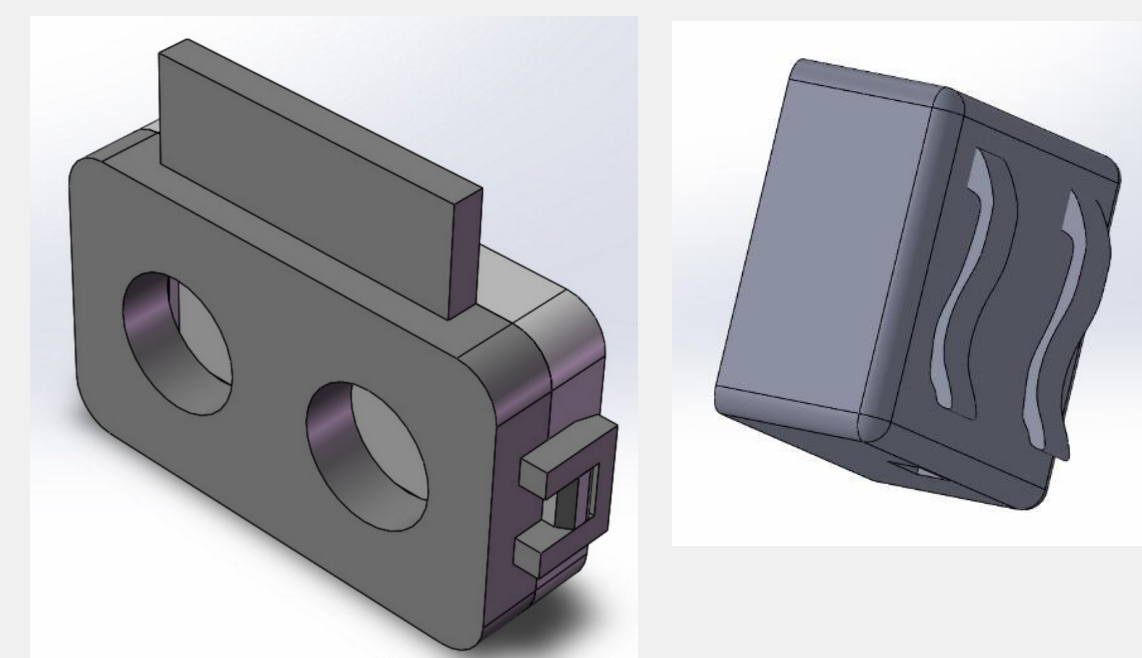
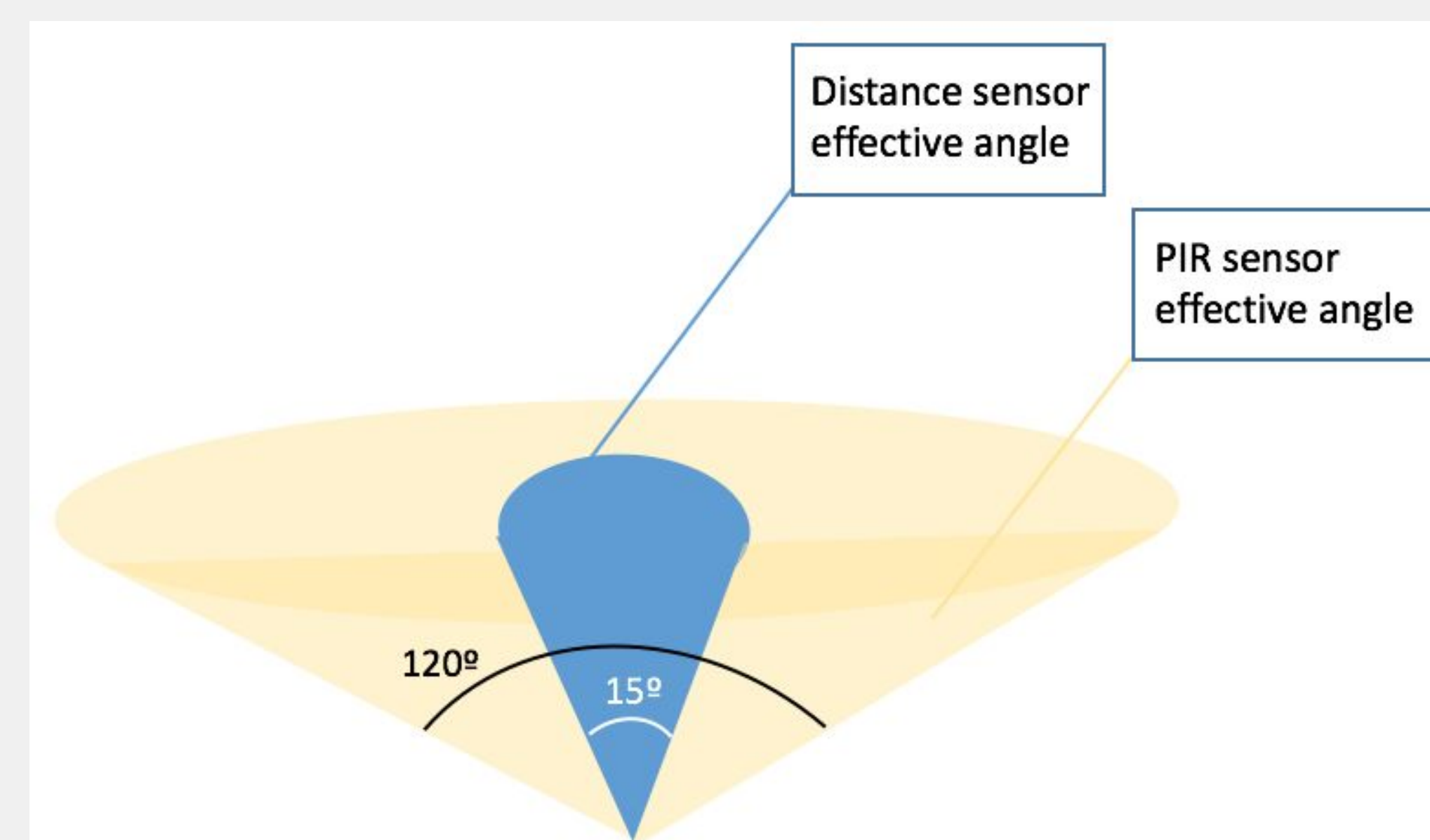
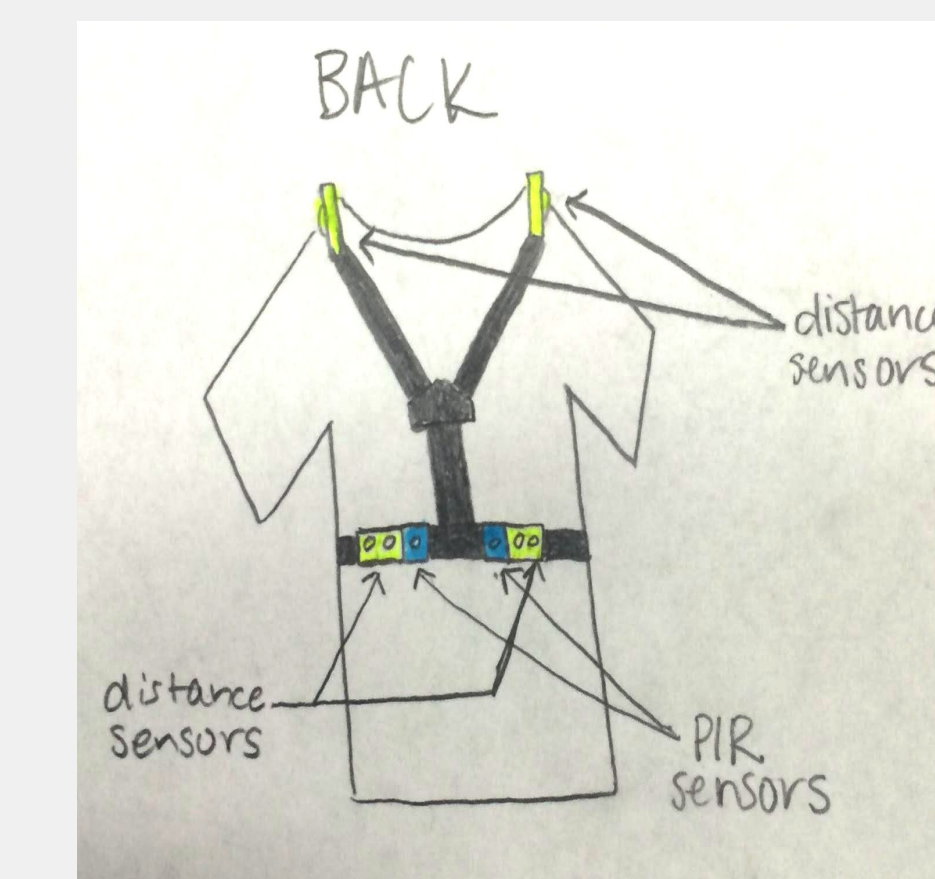
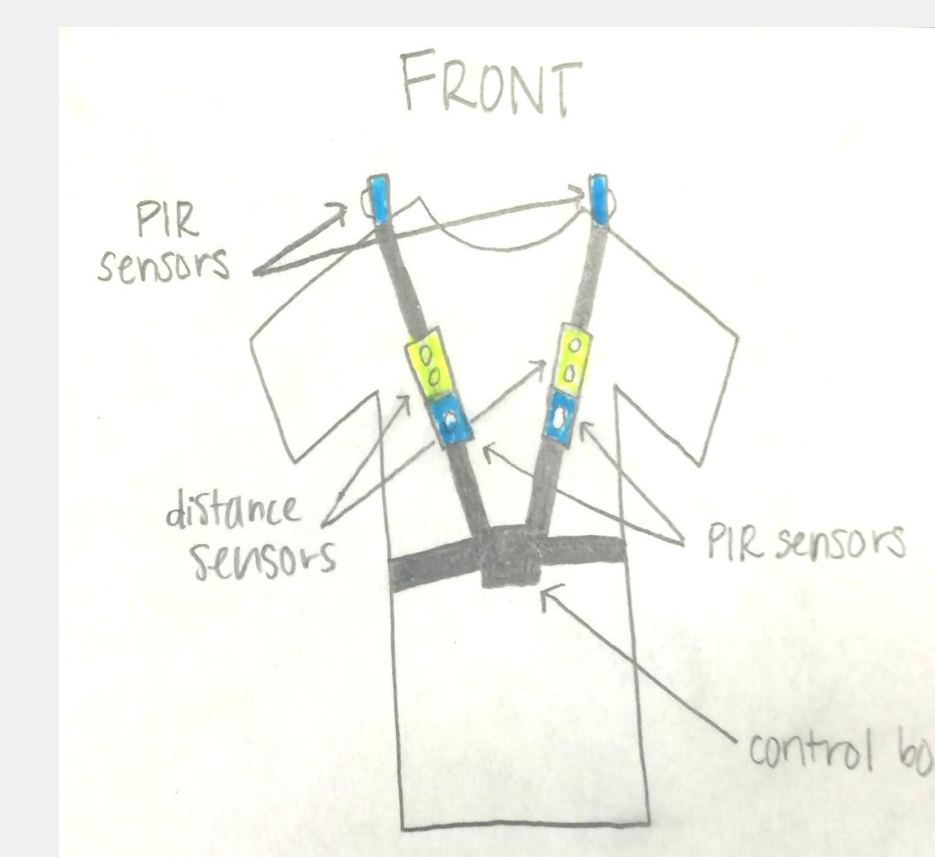

Figure 3: HC-SR04 housing³



- Two pairs of sensors on the chest, two on the back, one pair on each shoulder
- One motor on each shoulder and on each side
- If a PIR sensor is tripped, five distance sensor readings are taken
- If the average distance is less than 100cm, feedback is given

Future Work

- Upgrade the thermal sensors and battery pack
- Develop a more ergonomic and comfortable design
- Align the effective angles of the sensor pairings more closely
- Rework the code to include a delay in response to avoid unintentional sensing by the patient him/herself

Acknowledgements

Dr. Sarah Hagi, Prof. John Webster, & Prof. Beth Meyerand

References

- [1] National Cancer Institute. (n.d.). *Thyroid Cancer - for patients*. Retrieved from <http://www.cancer.gov/types/thyroid>
- [2] Softwaves. (n.d.). *Radiation*. Retrieved from <http://softwaves.net/RADIATION/Radiation-Softwaves.htm>
- [3] GrabCAD - CAD library. (2014, April 23). Retrieved from <https://grabcad.com/library/hc-sr04-housing-1>