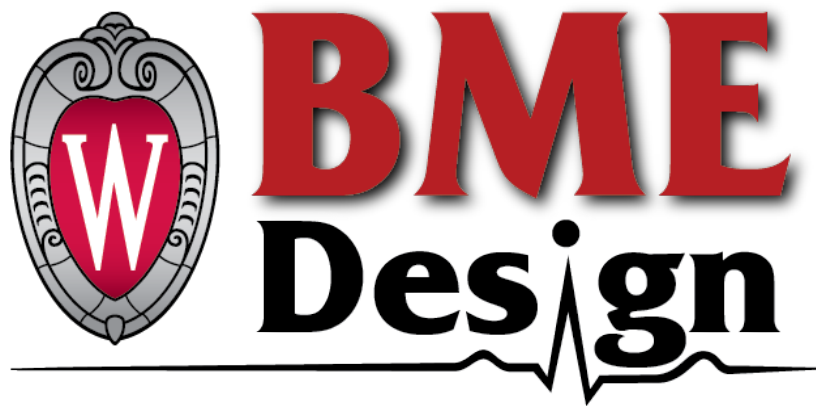


University of Wisconsin - Madison



## **Tissue Biopsy Dissociation**

BME 200/300

12/11/18

Client: Dr. Sameer Mathur

Advisor: Dr. Wan-Ju Li

Team Members: Patrick Kasl (BSAC), Hailey Frye (Communicator), Elizabeth Gunderson (Communicator), Samuel Moss (Team Leader), Saketh Challa (BWIG), Jesse Fan (BPAG)

## **Abstract**

Eosinophils have been found in the lumen of the blood vessels and lungs of asthma patients. Tissue resident eosinophils have also been found in the lung tissue of these same patients. It is believed that these eosinophils have different surface markers depending on the area of the body they originated from [1]. To study eosinophil surface markers, the cells must first be dissociated from the surrounding lung tissue. This project investigated methods to dissociate eosinophils from lung tissue while maintaining *in vivo* conditions as much as possible. By dissociating eosinophils from tissue, the surface markers on the cells could be analyzed by flow cytometry and subsequently compared to surface markers on the eosinophils obtained from blood and airways. Among other design considerations, this project aimed to minimize damage to the cells while at the same time yielding enough eosinophils for analysis by flow cytometry. To this end, the group integrated hydrogel beads into the client's gentleMACs dissociator and established protocol. Preliminary results indicate that including these beads increases cell yield by 400%.

# **Table of Contents**

<b>Abstract</b>	<b>1</b>
<b>Table of Contents</b>	<b>2</b>
<b>Introduction</b>	<b>3</b>
Motivation and Client Background	3
Current Methods of Dissociation	3
Problem Statement	4
<b>Background</b>	<b>4</b>
Relevant Published Research	4
Competing Designs	5
<b>Preliminary Designs</b>	<b>5</b>
Components of All Designs	5
Enzymatic and Gentle Agitation	5
Enzyme And MicroFluidic Device	6
Hydrogel Beads and gentleMACS Dissociator	6
<b>Preliminary Design Evaluation</b>	<b>7</b>
Design Matrix	7
Proposed Final Design	10
<b>Fabrication/Development Process</b>	<b>11</b>
Methods	11
Final Prototype	11
Testing	13
Results	17
<b>Discussion</b>	<b>18</b>
<b>Conclusion</b>	<b>19</b>
Future Work	19
<b>References</b>	<b>21</b>
Appendix I - Preliminary Design Specifications	23
Appendix II - Alginate Testing Protocol	24
Appendix III - Statistical Analysis	26
Appendix IV - Pictures of Microscope Slides	26
Appendix V- Materials Purchased	29

## **Introduction**

### **Motivation and Client Background**

The client Dr. Sameer Mathur, is an immunologist at the University of Wisconsin-Madison. He conducts asthma research, specifically pertaining to the role eosinophils play in asthma immunoregulation. His lab focuses on studying how allergens affect lung tissue and luminal blood vessel resident eosinophils. Currently, Dr. Sameer Mathur recruits asthma patients and performs bronchoscopies to gather their lung tissue. He uses this tissue to determine mechanisms that eosinophils use to regulate epithelial responses to innate immune stimuli and viruses. To perform these studies, eosinophils must be isolated from the tissue samples, while retaining cell viability and producing satisfactory yield. These factors ultimately prompt the need for a new, specialized tissue dissociation method.

Asthma is a common condition and it affects at least 3 million people in the United States. Like any disease, there are varying degrees to which asthma can affect daily life. For some, asthma can be a minor annoyance, for others, it can be life threatening. All asthma operates by the same mechanism. During an asthmatic reaction, airways are constricted, making it challenging for someone to breath. As air pollution is increasing for a larger portion of the population, the prevalence of asthma will only increase. Asthma is often initiated by an irritant or allergen, but can become chronic if the tissue of the airways maintains an inflamed state. Current medical dogma instructs treatment of asthma with a host of bronchodilator and anti-inflammatory drugs, as well as steroids. These treatments typically control the symptoms of asthma well, but are currently ineffective at curing the disease [1].

The main subject of the client's study is the tissue resident eosinophil. Eosinophils are a type of white blood cell. As such, they are a part of the innate immune system and are typically associated with their role in fighting viral and parasitic infections. Eosinophils contain large granules that contain the cell's peroxidase, RNase, DNase, lipase, and plasminogen. It is believed that the eosinophils play a role in an asthmatic response. The release of eosinophil granular contents will damage the allergen while irritating the lung tissue surrounding the allergen.

### **Current Methods of Dissociation**

Most tissue sample dissociation protocols use an enzymatic approach or a tissue dissociator machine such as the gentleMACs tissue dissociator. A large number of research papers discuss soaking tissues in various enzymatic solutions until complete dissociation is achieved. The majority of current dissociation methods follow the same basic steps: use a mixture of enzymes in conjugation with agitation at 37° C, followed by various washing and straining techniques. These steps are then repeated until the tissue is properly dissociated.

The gentleMACS tissue dissociator is commonly used in cases where a higher throughput is required. It works on a similar principle as the standard enzymatic dissociation but includes a specially formulated cap and conical tube that adds an element of mechanical dissociation. The cap has small ridges, rotors, and spacers that protrude. These interact with tissues to dissociate the cells. While a tissue is in the dissociator, a proprietary enzyme solution is often included.

Current techniques do not work for the client due to the small size of the tissue samples that are obtained from a bronchoscopy procedure.

## **Problem Statement**

Dr. Mathur's research group receives tissue samples from lung biopsies prior to and after the induction of asthma. He is specifically interested in the effect tissue resident eosinophils have on asthma. The biopsies he receives are too small for current tissue dissociation methods. This device must be able to dissociate 1 mm<sup>3</sup> to 2 mm<sup>3</sup> pieces of tissue while allowing for the interrogation of gene expression in addition to cell surface markers. The duration of the dissociation process must be less than 4 hours. The cost of all materials must be around \$10 if the device is disposable. If the device can be reused and sterilized, the total cost can be \$300.

## **Background**

### **Relevant Published Research**

Tissue biopsies are a common tool, especially in the cancer field, used to perform analysis critical to the production of various cell therapies. The extraction of cells through tissue dissociation will always be harmful to cells, specifically those that require integrin bound attachment to the extracellular matrix (ECM.) The application of enzymes and the intense change in physical surroundings will be the most damaging aspects of dissociation for cells resident in tissues. Cells, such as cardiomyocytes, that are typically bound to the extracellular matrix are susceptible to programmed cell death within a short period of time if left unattached to ECM in biological conditions. This was a lower concern for this project due to the fact that eosinophils are not bound by integrin receptors to the ECM. There is still debate as to whether there could be subtypes of these cells that act differently in respect to their interactions with the ECM. The eosinophils still interact with the ECM and are surrounded by it, but are not bound to it through integrin receptors like a variety of other cells. While the absence of ECM binding by eosinophils will aid in dissociation, specific enzymes should be chosen to ensure cell surface markers are not affected. Successful protocols for dissociating tissue commonly include soaking the tissue in enzyme as well as the use of some physical stimulation [2].

As previously mentioned, enzymatic dissociation is a commonly used technique to obtain single cell suspension. For example, Cooper et al. utilized a typical enzymatic dissociation in order to analyze tissue resident natural killer (NK) cells by flow cytometry [2]. They started by mincing the samples into 4-6mm<sup>3</sup> lung tissue fragments and putting them into cold Roswell Park Memorial Institute medium (RPMI), then transferred these fragments to "complete RPMI" for 16 hours to remove blood. The samples were then digested in collagenase and filtered through a 70-µm filter. Last, the group stained the cells and counted them on the hemocytometer.

The gentleMACs dissociator is also commonly used to dissociate tissue, and a representative protocol is outlined in a publication by Bandyopadhyay et al. The samples are first dissected and then placed into a prewarmed buffer solution of DPBS, 10 mM HEPES, 150 mM NaCl, 5 mM KCL, 1 mM MgCl<sub>2</sub>, 2 mg/mL collagenase type A, 1 mg/mL dispase II, 0.5 mg/mL porcine pancreas elastase, and 2 mg/mL bovine pancreas DNase-I. The cocktail is then put into a

gentleMACs C tube with 8 g of tissue per tube and 10 mL of cocktail. The sample tube and contents are then placed onto the gentleMACS tissue dissociator machine and run through a preset program. After the dissociation cycle, the contents are strained through a 100- $\mu$ m filter [3].

The client was most concerned with the duration of the dissociation process. It has been shown that the expression of genes and surface markers can change during a process such as dissociation. These alterations and damages could be a result of an actual change in the mRNA transcription and associated cell surface marker protein production, surface marker internalization, enzymatic damage to the surface markers, or a combination of these. Our client desired a device or method to quickly dissociate live eosinophils from lung biopsies. Our client indicated that the device or procedure should cost around \$10 per use. In depth product design specification can be found in Appendix I.

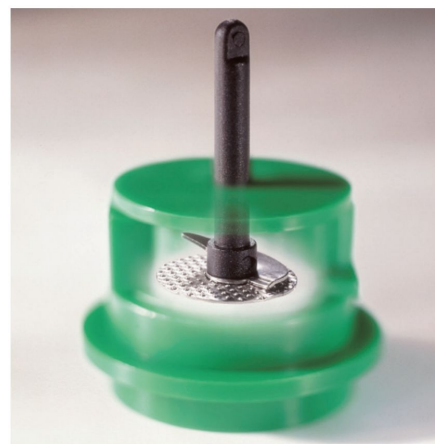
## Competing Designs

Two products exist on the market for use in tissue dissociation or homogenization. One is the aforementioned gentleMACS dissociator. The other is the BD™ Medimachine which has disposable, specially formulated tubes with steel strainers and a rotating blade that works to homogenize the tissue.

Interestingly, there exists two separate products that utilize small beads made of stainless steel or glass to aid in homogenizing tissue samples. This process however, leaves the cells entirely non viable because the stiffness of the steel and glass provide too much mechanical stimulus to the cells. This dissociation method demonstrates the need of a lower stiffness bead to maintain cell viability.



**Figure 1: Closer look at a gentleMACS C tube [4]**



**Figure 2: A cutout image of the BD Medimachine dissociation chamber. [5]**

## **Preliminary Designs**

### **Components of All Designs**

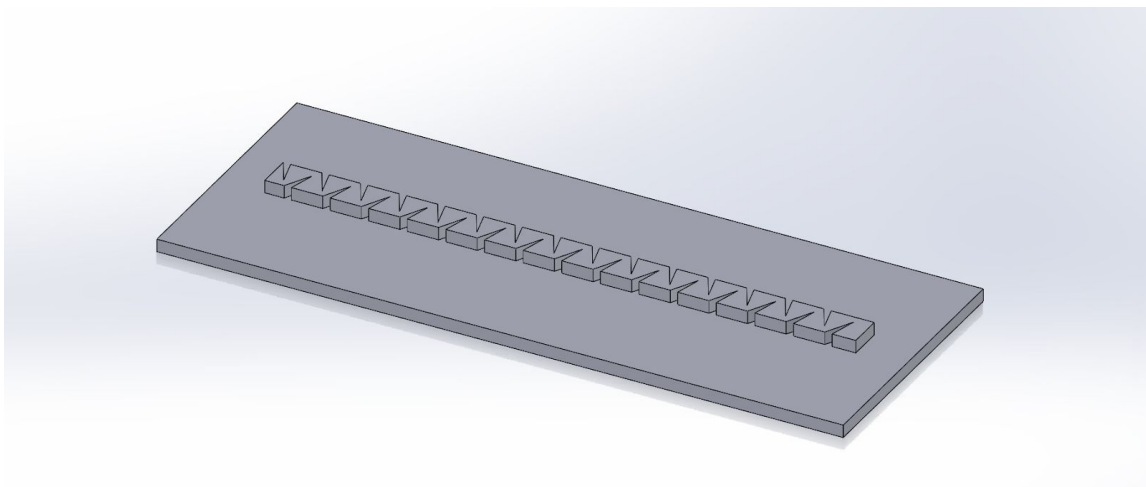
Each design varies in the amount of physical stimulation that would be used to dissociate the tissue. Every design has the small pieces of tissues (biopsies) soaking in an enzyme solution prior to dissociation. Each design must show reproducible results. These designs also all prioritize duration of tissue dissociation and cell viability after dissociation.

### **Enzymatic and Gentle Agitation**

The enzymatic and gentle agitation method is the simplest approach of the three design methods considered. This method involves soaking the small pieces of tissue within a mixture of enzymes [3]. This enzyme mix would need to be both gentle and quick, thereby not harming any of the cells or their vital surface markers. The tissue soaks within the enzyme mix for approximately 4 hours while simultaneously undergoing gentle agitation on an agitation plate. The solution is then filtered through a 70  $\mu\text{m}$  filter. It is hoped that this process causes the tissue to dissociate completely allowing for it to be analyzed by flow cytometry.

### **Enzyme And Microfluidic Device**

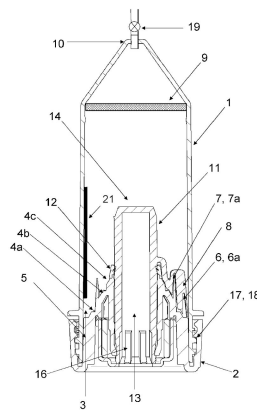
The unique characteristic of this dissociation process is the incorporation of a microfluidic device to create turbulent flow. Using a microfluidic device made of PDMS would allow a mechanical means of dissociation that is cheap and biocompatible [6]. The small piece of tissue should be soaked in an enzyme solution to soften the tissue. Subsequently, the samples will begin the dissociation process. Then, the tissue would be passed through the fluidic device and by the differences between laminar and turbulent flow, the tissue would be broken up into smaller and smaller pieces. The resulting tissue should be prepared to undergo flow cytometry in order to analyze any eosinophils obtained from the inflamed lung tissue.



**Figure 3:** *Microfluidic device mold to create turbulent flow to dissociate the tissue.*

## **Hydrogel Beads and gentleMACS Dissociator**

The main focus of this design is to limit the amount of time the tissue biopsy sample spends in solution with enzymes. The dissociation process is performed by soaking tissue in an enzyme solution for 20 minutes. The sample and enzyme solution are then placed in the gentleMACS dissociator with hydrogel beads. The gentleMACS machine dissociates tissue by swirling the sample in a specially designed conical tube. As shown in Figure 1, the conical tube is able to dissociate samples using various ridges, a rotor, and spacers. Hydrogel beads are added in the conical tube with the tissue sample because the gentleMACS dissociator is designed to dissociate tissue samples larger than 1 mm<sup>3</sup>. By placing the tissue sample in the dissociator with hydrogel beads, the volume and mass of the content being dissociated will be increased. A greater volume and mass will allow the gentleMACS dissociator to more effectively dissociate the tissue. Finally, the hydrogel beads surrounding the tissue sample will provide further mechanical stimulation which will aide in the dissociation process. The resulting solution will be filtered and analyzed through flow cytometry.



**Figure 4:** *Design schematic of the conical tubes used with the gentleMACS dissociator.*

## **Preliminary Design Evaluation**

### **Design Matrix**

The following design matrix evaluates three methods to dissociate 1 mm<sup>3</sup> pieces of lung tissue. The evaluation criteria was derived from the client's need to obtain viable cells with minimal damage to cell surface markers. An increase in procedural duration will decrease cell viability and increase cell surface marker damage. Each procedure was also evaluated for ease of fabrication and use. While the client's lab is well equipped, ease of fabrication and use will allow for quick implementation of the dissociation procedure into the lab. The goal is to minimize time between bronchial extraction and single cell analysis by flow cytometry. The client has requested that the average cost per procedure would be less than \$10.



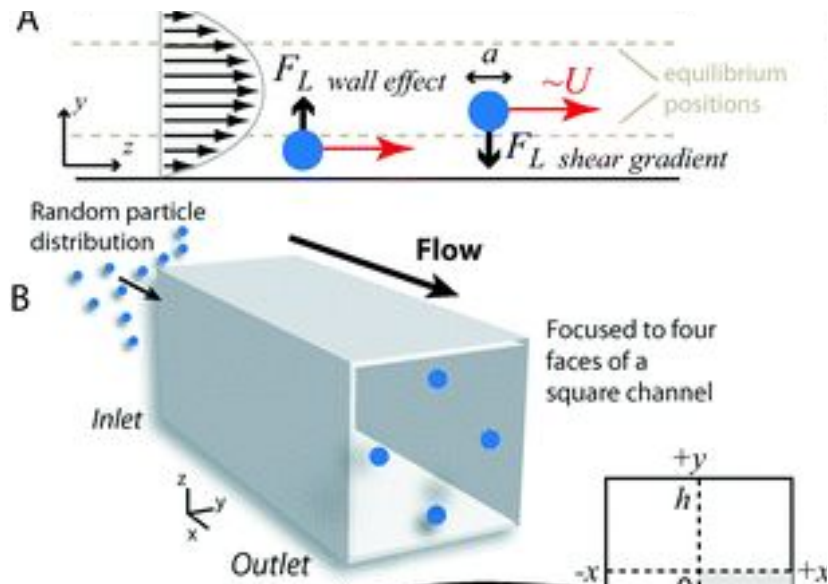
Single cell viability and surface marker integrity were the primary concern of each design. The team anticipated that the gentleMACS dissociator with hydrogels would allow for dissociation of the most viable single cells with the least varied cell surface markers.

	Weight	Enzyme and Gentle Agitation (EGA)		Enzyme and Microfluidic Device (EMD)		Hydrogel Matrix with the gentleMACS Dissociator (HMGD)	
Cost	10	5/5	10	3/5	6	4/5	8
Ease of Fabrication	15	5/5	15	3/5	9	4/5	12
Duration of Dissociation Process	20	3/5	12	4/5	16	5/5	20
Cell Viability	20	2/5	8	1/5	4	5/5	20
Effect on Cell Surface Markers	25	4/5	20	3/5	15	5/5	25
Ease of Use	10	5/5	10	3/5	6	4/5	8
<b>Total</b>			75		68		93

**Table 1:** Design Matrix of the three designs. Criteria is outlined on the left, evaluations of that criteria for each design is highlighted in green.

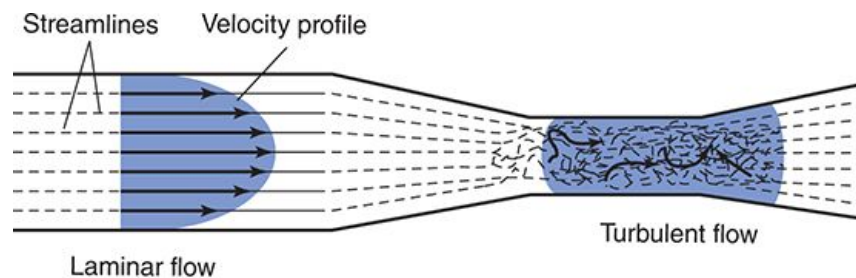
The enzymatic approach with gentle agitation (EGA) was evaluated using the above design matrix. EGA would be the least expensive as Dr. Mathur's lab already owns the materials required for this process. Dr. Mathur's lab has already purchased the gentleMACS device. Miltenyi also sells recommended, proprietary enzymes for use with the gentleMACS device. EGA also scored highly in ease of use and fabrication as this method would only involve mixing enzymes with the tissues and there would be no fabrication involved. Agitation based dissociation techniques are frequently employed in the lab; they would require minimal training. Compared to the other designs, this process would have the longest duration of dissociation. This translates to the method's two low scores in the cell surface markers and cell viability categories [7].

The second design evaluated was an enzymatic microfluidic device (EMD). The group working on this project last year determined that a microfluidic device would be the most appropriate strategy to dissociate the tissue sample. For this reason specific discussion why our group did not move forward with a microfluidic design is warranted. In a microfluidic device, flow profiles typically follow a laminar flow regime. Under laminar flow, the tissue sample is mainly subjected to convection forces along with minimal shear forces from the non-slip boundaries. In order to minimize resistance, the tissue sample would be preferentially directed to the equilibrium position of the channel as illustrated in Figure 5. As a result, the tissues would experience a shear force approaching zero.



**Figure 5:** Image that demonstrates the various forces within a microfluidic device [8]

Under laminar flow regimes, convection forces would not translate any force to the tissues other than the hydrostatic force that is driving the flow. This hydrostatic force is uniform throughout the liquid. For this reason, the tissue samples would not experience anywhere close to the previous group's shear force approximation. In order to achieve flow profiles in a microfluidic device that would aid in dissociating the client's tissue sample, turbulent flow would need to be produced. In turbulent flow, the velocity profiles will be randomly distributed, appearing similar to those pictured in the right side of Figure 6. These streamlines, once turbulent, could usefully interact with the tissue samples.



**Figure 6:** Image that shows demonstrates the different types of flows in a microfluidic device [9]

In order to induce turbulent flow in a newtonian fluid, a Reynolds number of  $\sim 3000$  must be achieved.

$$Re = \frac{\rho v L}{\mu}$$

**Equation 1:** Calculation for Reynold's number ( $Re$ ) based on density ( $\rho$ ) fluid velocity ( $v$ ), characteristic length ( $L$ ), and kinematic viscosity ( $\mu$ ).

The previous group utilized channels with a 0.0001 m height and 0.00064 m width. Any microfluidic device created would design would utilize a channel of similar dimensions. Under these parameters, the characteristic length can be calculated using Equation 2 .

$$L = \frac{4 * \text{Cross sectional area}}{\text{Wetted Perimeter}} = 0.00017 \text{m}$$

**Equation 2:** *An equation to determine characteristic length in a rectangular channel.*

The liquid in the device would be mainly water; it can be assumed that the characteristic parameters are identical to water. Based upon this assumption, the dynamic viscosity ( $\mu$ ) = 0.00089 Pa.s and density ( $\rho$ ) = 997 kg/m<sup>3</sup>. Using these parameters, it can be determined that the velocity the fluid must reach to achieve turbulent flow, obtained by Equation 3, would be 26.7 m/sec or 60 mph.

$$\text{Velocity} = v = \frac{Re * \mu}{\rho L}$$

**Equation 3:** *Rearrangement of calculation for Re, solving for velocity.*

Intuitively, this is an extremely high velocity, and the force required to induce this speed flow would significantly decrease cell viability. Any force on cells above 0.356 Pa has been shown to decrease cell viability [6]. The force needed to move liquids in a rectangular channel is given by Equation 4.

$$P = AVR$$

**Equation 4:** *The pressure (P) needed to drive flow at a given cross sectional area (A), velocity (V), and resistance (R)*

Based on the stated parameters, and solving for pressure, it can be determined that the cells would initially be subjected to 4932.43 Pa. Therefore, no viable cells would remain after dissociation. Considering other design parameters, EMD would be the most expensive and the most difficult to fabricate. For these reasons, the microfluidic design received the lowest scores in the design matrix in these categories [10].

Finally, the design using hydrogel beads with the gentleMACS dissociator machine (HMGD) was evaluated based on the design criteria. HMGD would require the shortest duration in enzyme solution and would therefore recapitulate surface markers the most accurately. As such, HMGD scored the highest in the effect on surface markers category. The hydrogels would add mechanical dissociation as seen in Figure 10. The beads' stiffness, along with bead size could be optimized to prevent extensive mechanical stimulation. Resultantly, cells would not be lysed. Fabrication of hydrogels would be simple, requiring only standard lab techniques. The cost of HMGD was scored in between the microfluidic device and enzyme approach. The main cost of this method would be that of using the gentleMACS tubes. As such, this approach would be less expensive than the \$10 per use benchmark the client set.

## **Proposed Final Design**

Based on the criteria discussed in the former section, the hydrogel beads with the gentleMACS dissociator procedure scored the highest on the design matrix. The hydrogel beads would have the smallest impact on cell surface markers, cell viability, and would have the shortest duration of dissociation process. These aspects ultimately are the most important criteria.

The material chosen to create the hydrogels should allow for various sizes of hydrogels to be fabricated. Additionally, the stiffness and swellability of the beads should be controlled given the different hydrogel material. This can be done by controlling the amount of crosslinking in each bead. The ability to vary the cross linking will allow for optimization of the dissociation process [11]. The hydrogel material should also be biocompatible and not interact chemically with the tissue or the enzyme solution. Sodium alginate and polyethylene glycol monomethyl ether monomethacrylate (PEGMMA) along with other materials fit this criteria.

## **Fabrication/Development Process**

### **Materials**

With the criteria for the hydrogel material in mind, sodium alginate was chosen to fabricate the hydrogel beads. Sodium alginate is biocompatible and relatively inexpensive. By increasing the concentration of the cross linker,  $\text{CaCl}_2$ , and concentration of sodium alginate the stiffness of the hydrogels could easily be altered. HEPES was also used as a buffer during fabrication. The sodium alginate,  $\text{CaCl}_2$ , and HEPES were all obtained through the UW BME department.

Polyethylene glycol was also considered for the hydrogel material. PEGMMA is biocompatible and the stiffness could be easily controlled. Polyethylene glycol methacrylate, irgacure, and a photoinitiator for UV light, were purchased. A protocol was followed, but the PEGMMA hydrogels never crosslinked. Sodium alginate hydrogels successfully crosslinked and were used for the final design.

### **Methods**

Three  $\text{mm}^3$  spherical sodium alginate hydrogels were synthesized by dropping 3.5% sodium alginate from a pipette into a 200mM  $\text{CaCl}_2$  solution stirred at 200 rpm. The solution was then filtered and hydrogels were obtained. These hydrogels were stored in water until they were required for testing. Although the synthesis of PEGMMA hydrogel beads was attempted, they were never able to cross link during fabrication and the cause of this failure was never identified.

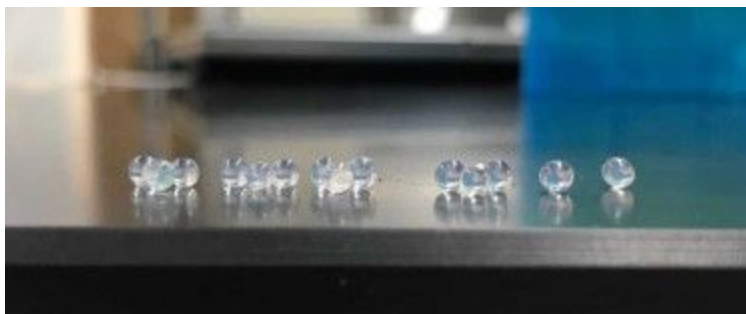
Testing continued with only the sodium alginate hydrogel beads. Following the synthesis of these beads, their ability in disassociating tissues was tested by using a sample of rat lung tissue. After allowing the tissue to soak in a mixture of enzymes, 4.4 g of hydrogel beads were added to the conical tube along with the tissue and enzyme solution. This mixture was ran on the gentleMACS dissociator and the resulting mixture was filtered through 70  $\mu\text{m}$  filter. It was then centrifuged, and counted on a hemocytometer to quantify the number of cells that survived the

dissociation process. The cell solution was put through a cytopsin. This resulted in the dissociated cells to be put on a slide for further analysis.



**Figure 7 :** *Sodium alginate hydrogel fabrication setup*

## **Final Prototype**



**Figure 8:** *Final sodium alginate hydrogel design.*

## **Testing**

### **Mathematics**

The lower speed lung setting on the gentleMACS rotates the rotor in the conical tube at 174 rpm, and the average radius of rotation is 1 cm. Therefore, on average the beads are moving with a velocity of 0.1822128 m/sec. The beads have a stiffness of 150 kPa and their velocity before and after collision with an object, like the tissue sample, varies by the coefficient of restitution, seen in Equation 5 [12].

$$\text{Coefficient of restitution } (e) = \frac{\text{Relative velocity after collision}}{\text{Relative velocity before collision}}$$

**Equation 5:** *The coefficient of restitution is the ratio of velocity after and before collision.*

Intuitively, as the velocity of the object after the collision cannot be greater than the velocity before the collision, the ranges of the coefficient of restitution falls within the ranges of zero and one. The coefficient of restitution is proportional to the Young's modulus (stiffness or E) and be approximated using Equation 5 if coefficient of restitution ( $e$ ), dynamic yield strength ( $S_y$ = unknown), effective elastic modulus ( $E'= 150$  kPa), density ( $\rho= 1.123$  g/cm<sup>3</sup>), velocity at impact ( $V_1= 0.182$  m/s) are known [13].

$$e = 3.1 \left( \frac{S_y}{E'} \right)^{5/8} \left( \frac{R_1}{R} \right)^{3/8} \left( \sqrt{\frac{E'}{\rho}} \frac{1}{V_1} \right)^{1/4}$$

**Equation 6:** *A way to estimate coefficient of restitution by measuring various parameters.*

Assuming stiffness (E) varies proportionally with yield strength ( $S_y$ ), the limit of  $e$ , as stiffness is increased, approaches one. A coefficient of restitution closer to one results in a final velocity after collision that is close to the initial velocity. The velocity before and after collision can be related to the force applied by the following equation.

$$\mathbf{J} = \int_{t_1}^{t_2} \mathbf{F} dt = \Delta \mathbf{p} = m\mathbf{v}_2 - m\mathbf{v}_1$$

**Equation 7:** *A method to determine force applied to an object when the change in velocity is known.*

$$F = \frac{m(v_i * e - v_i)}{\Delta t}$$

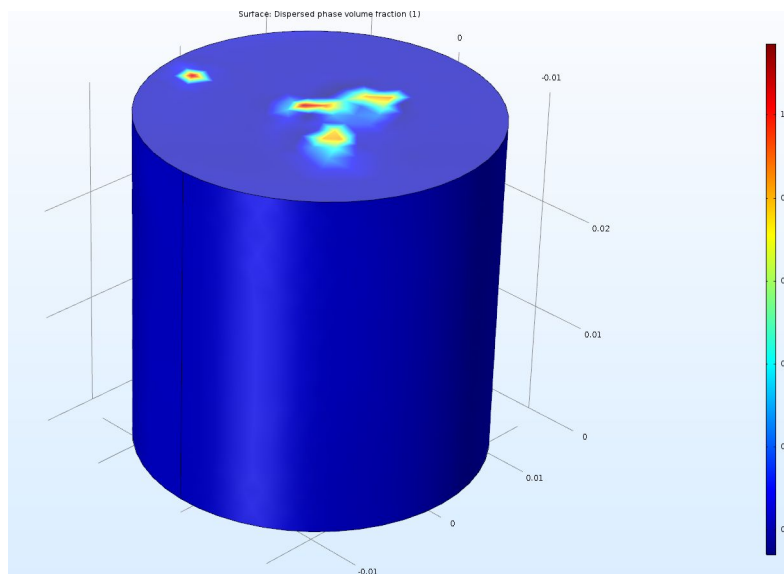
**Equation 8:** *Force can be calculated from measurable parameters with this equation.*

These equations return values of the force that the bead experiences based on the hydrogel-tissue interactions. By Newton's third law, the force experienced by the tissue sample will be equivalent.

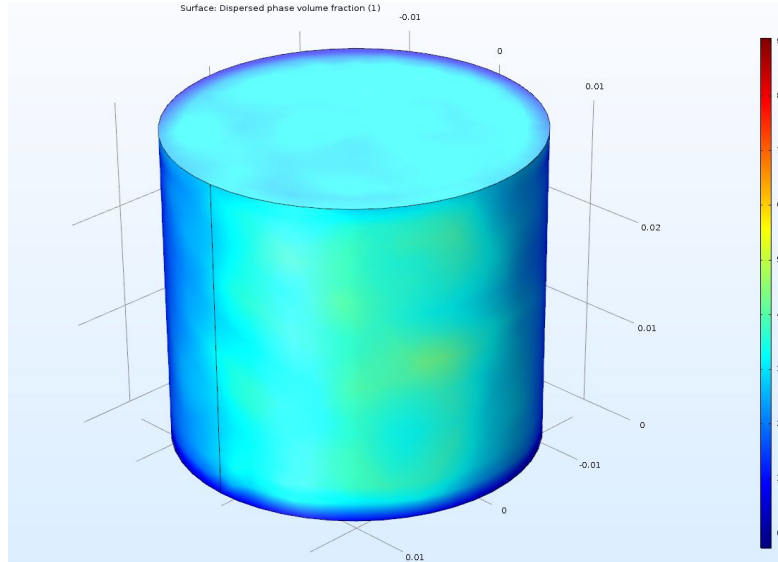
More sensitive instruments would be required to determine the dynamic yield strength and the change in time during hydrogel collision interactions. These measurements could be accomplished using a more sensitive MTS machine and by making a simplified collision system and recording under a microscope the time intervals over which interactions take place, respectively. Once these are determined, the force that was applied with each interaction can be calculated. Although there is currently no access to the equipment required to make these measurements, it can intuitively be determined that increasing stiffness will decrease the amount of time over which the interactions take place. Holding everything else constant, it can be concluded that increasing stiffness will increase the force of each hydrogel-tissue interaction.

### Simulations

COMSOL multiphase fluid dynamic simulations were run to approximate forces experienced by the tissue samples in enzyme solution alone (Figure 9) or with hydrogel beads (Figure 10). Because the solution is well mixed, it can be assumed that the force experienced at each interaction (hydrogel-hydrogel, hydrogel-tissue, hydrogel-tube) will be equivalent. Therefore, the simulation approximating the force applied to the side of the tube will directly translate to the force applied to each tissue sample. One of these pressure simulations can be observed in Figure 9, with “particles” modeled as water molecules. There is a uniform dark blue on the side of the tube. This color expression represents low pressure application by the fluid. Lighter blue shown in Figure 10 represents increased pressure on the side of the conical tube.

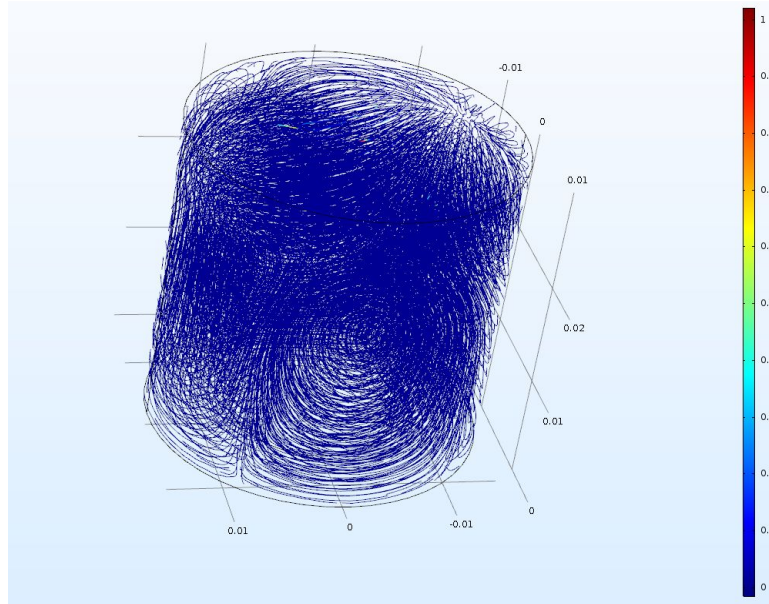


**Figure 9:** Comsol simulation showing pressure distribution on a conical tube with just tissue while machine is run



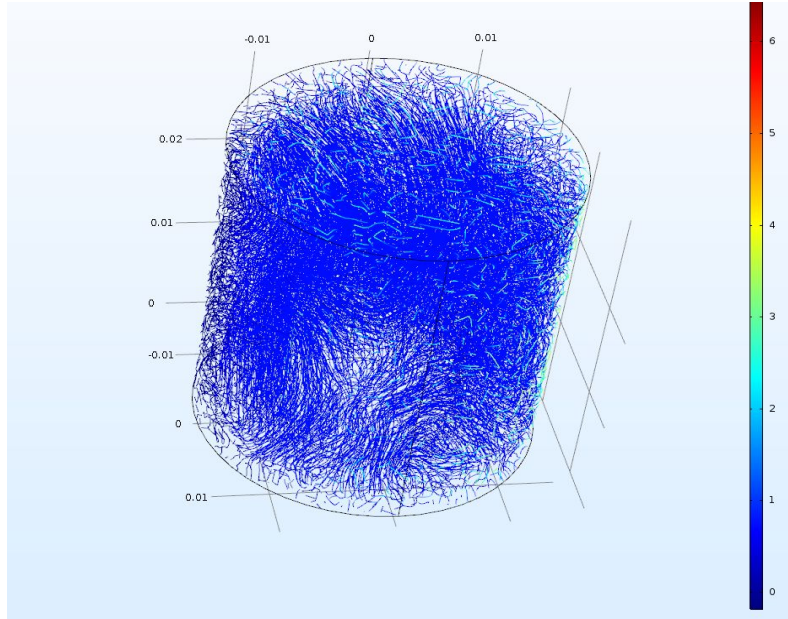
**Figure 10:** *Comsol simulation showing pressure distribution on conical tube with tissue and hydrogel beads while machine is run.*

The above pressure simulations also have associated particle tracking simulations. This tracking is simulated in Figures 11 and 12. Dark blue streamlines can be observed in Figure 11. These consistently dark blue lines indicate that the particles in the simulation traveled in a “laminar” uniform flow profile at consistently low velocities. Lighter blue streamlines can be observed in Figure 12. This solution simulates hydrogels as the second phase particles. It can also be observed that the streamlines vary in color. This indicates the particles had varying velocities. Also, the flow profile appears more “turbulent,” or choppy. From this, it can be concluded that a tissue sample in this environment will experience an increased cumulative number of interactions. These tissue interactions will happen primarily with the hydrogel beads.



**Figure 11:** *Comsol simulation of velocity profiles in a conical tube with just tissue and no hydrogels while machine is run.*





**Figure 12:** *Comsol simulation of velocity profiles in a conical tube with tissue and hydrogels while machine is run.*

### Physical

To test the prototype, three technical replicates with hydrogels were run against three control replicates without beads. For the control conditions, tissue was soaked in .15% collagenase solution for 20 minutes at 37° C. The enzyme solution and tissue biopsies were then placed into the gentleMACS conical tube and run on the slowest setting for lung tissue three times. The total duration of dissociation in the gentleMACS machine was two minutes. The solution was then passed through a 70  $\mu\text{m}$  filter. The testing of the hydrogels followed the same protocol, except 4.4 g of hydrogels were added to the conical tube before using the gentleMACS dissociator. After filtering, the cells were centrifuged and then re-suspended. This allowed for cells to be counted using a hemocytometer and to quantify the number of cells that were dissociated.



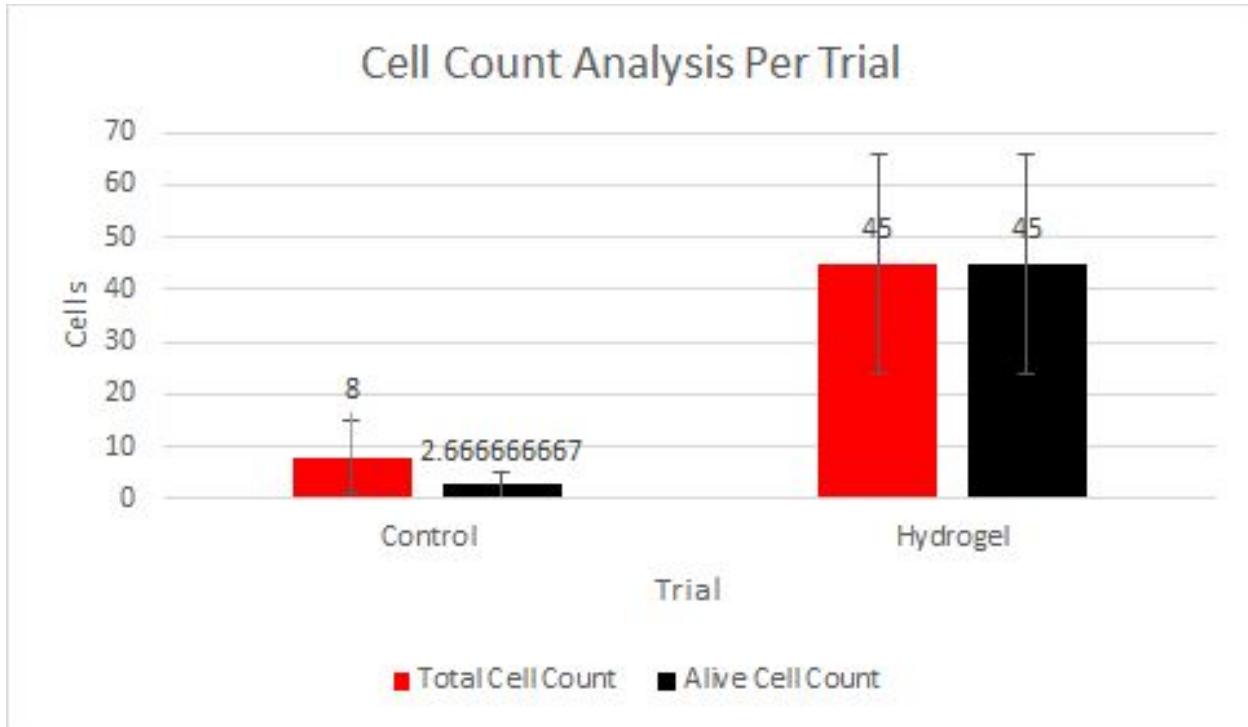
**Figure 13:** *Hydrogels, tissue, and enzyme solution in gentleMACS conical tube during testing*

The total dissociation procedure with the hydrogels took approximately 30 minutes. This time was well within the parameter set in the design criteria. With the expedited process, we assume the cell surface markers on the dissociated cells did not have time to change substantially. Additionally, the hydrogels are easy to fabricate and use. The hydrogel dissociation approach meets all of the product design specifications.

Testing the control and hydrogel conditions allowed for direct measure of effectiveness between the conditions. Results of testing showed whether the control tube or tube with hydrogels yielded more dissociated cells and percentage of the dissociated cells that are still alive.

## **Results**

The results gathered through experimental trials indicate an increase of the total cell count and alive cell count between the control and hydrogel conditions. The control condition, with no hydrogels, had an average of 8 total cells dissociated and approximately 2.67 alive cells per square on the hemocytometer. This translates to roughly 40,000 cells per milliliter in suspension. The experimental trial, with hydrogels, had an average of 45 total cells per square on the hemocytometer and all of the cells were alive. This translates to roughly 225,000 cells per milliliter that would be found in the solution. A one-sided t-test for the hypothesis that  $\mu_1 < \mu_2$  (the hydrogel condition obtains more live cells) between the control and hydrogel conditions as counted by the number of cells that were alive, returns a p-value of 0.043. Being that  $0.043 < 0.05$ , the null hypothesis,  $\mu_1 = \mu_2$ , was rejected. Based on these calculations, the evidence supports the claim that the inclusion of beads in the test condition increase the number of viable dissociated cells that are obtained during the procedure.



**Figure 14:** Total cell count (red) and alive cell count (black) for both the control (no hydrogels) and experimental (hydrogels) as counted with the hemocytometer with trypan blue

The hydrogel bead method successfully dissociated 9.3% of total cells from the sample while the control only dissociated 3.2%. These percentages were calculated by dividing the mass of cells dissociated from each condition by the estimate of total mass of cells in the samples of each condition. The total mass of cells per condition was calculated by multiplying the total weight of tissue for each sample by two thirds. According to Muiznieks et al. one third of the tissue weight of a lung is due to the ECM while the remaining two thirds can be estimated to be the weight of the cells [14]. The average of the mass of cells for the two conditions was then calculated. The mass of cells dissociated was calculated by multiplying  $3.5 \times 10^{-9}$  and 40,000 for the control samples  $3.5 \times 10^{-9}$  and 225,000 for the hydrogel samples [15].

## **Discussion**

Since there was a statistically significant difference between the control and the hydrogel conditions for the number of alive cells, it can be concluded that the addition of hydrogels into the gentleMACS dissociator is an effective way to increase the amount of disassociation for small pieces of tissue. Once this process is optimized, it can be a viable option for Dr. Mathur's lab. Previous experiments attempted to dissociate tissue using glass and steel beads, but hard materials proved to be too stiff and caused most of the cells to lyse. To address this problem, we chose to use hydrogels. They are biocompatible and their stiffness, swellability, and size is controllable. The hydrogels that we used were about the same size as the tissue sample itself. However this size was simply chosen because we thought it would yield the best results and was not based on any data. In order to determine the most effective type of hydrogels, we tested

varying stiffness of the beads themselves and found that when a higher concentration of the cross-linker was used, a higher yield of cells was obtained.

One limitation of using collagenase as the enzymatic solution is that it requires  $\text{Ca}^{2+}$  to be activated. The excess  $\text{Ca}^{2+}$  can further crosslink the sodium alginate beads. This obscures the analysis and cultures of cells. If  $\text{Ca}^{2+}$  is required for enzymatic activation, then a different kind of hydrogel must be used. Another limitation of our design is that we only know that it reliably works with the gentleMACS dissociator. Although many other dissociators follow a similar mechanism to the gentleMACS, this design may need to be modified in order to make sure that it works for all types of dissociators.

## **Conclusion**

Dr. Sameer Mathur and his lab need to dissociate cells from inflamed lung tissue. The biopsies received are too small for current dissociation methods. To aid in the dissociation of viable cells with intact surface markers, alginate hydrogel beads were fabricated. The hydrogel beads were added to the gentleMACS conical tube to add mechanical stimulation to the tissue samples. When tested against a control, the hydrogel beads dissociated significantly more viable cells.

Sodium alginate beads were successfully cross linked, but PEGMMA beads were unable to successfully crosslink. The PEGMMA materials were set aside for future work because enough potential was shown with the alginate materials to complete this semester's goal. Because the hydrogel beads function strictly as a mechanical operator, there may be many other materials that can function similarly as dissociation beads. However, alginate proved to be an effective, cheap, and customizable material.

## **Future Work**

The next stage in this project would start with the optimization of the hydrogel beads. Various sizes, swellabilities, and stiffnesses would be tested and analyzed in the same fashion as the final testing. A best fit curve being applied to this data in order to determine optimal size, swellability and stiffness. This same approach can be applied to the gentleMACS dissociator settings to determine the optimal rpms for total cells and cell viability.

Once the optimal mechanical parameters are determined, the bead material would be analyzed and optimized in the same fashion. To optimize this condition, criteria from the design matrix must be considered. Calcium is used to activate collagenase; it is also the cross-linker for the alginate. Calcium's usage in solution caused extra alginate debris leading to sub-standard results. Due to these reasons, other hydrogel materials will most likely be better for this dissociation method compared to alginate.

An alternative material to alginate is PEGMMA. This material is cross linked through photo radicalization unlike the divalent cation method for alginate. This allows uncrosslinked PEGMMA to be in solution and not become crosslinked with the calcium in solution, solving the debris problem.

Once all optimal mechanical parameters and bead material have been determined, the final design should be tested using an inflamed human lung tissue sample. The sample of dissociated cells should be analyzed through flow cytometer. Flow cytometry would allow the client to determine the accuracy of the surface markers on the dissociated cells.

## **Acknowledgements**

The Tissue Biopsy Dissociation design team thanks Dr. Sameer Mathur, and Paul Fichtinger for providing the opportunity, necessary equipment, and assistance with the project. Thank you to Dr. Puccinelli and the UW BME department for providing the materials for synthesizing hydrogels. Additionally, the team thanks Bobby Weishar for giving us a baseline protocol for sodium alginate hydrogel fabrication. Finally, the team thanks Dr. Wan-Ju Li for providing insightful guidance and advice as well as helping us at every stage of this project.

## **References**

- [1] AJ, W., “Eosinophil Trafficking in Asthma,” *Clin Med (Lond)*. vol. 1, no. 3, p. 214-218, May 2001. [Abstract]. Available: <https://www.ncbi.nlm.nih.gov/pubmed/11446618?dopt=Abstract> [Accessed 9 Oct. 2018].
- [2] Cooper, Kristoffer, Salim, Wilkinson, T. M. A., K. J., and Grace E., “Human CD49a Lung Natural Killer Cell Cytotoxicity in Response to Influenza A Virus,” *Front Immunol*. vol. 6, p. 1671, July 2018. [Online]. Available: <https://www.frontiersin.org/articles/10.3389/fimmu.2018.01671/full>. [Accessed: 09-Oct-2018].
- [3] “Enzyme Explorer Key Resource: Collagenase Guide,” *H2NC6H4CO2C2H5*. [Online]. Available: <https://www.sigmaaldrich.com/life-science/metabolomics/enzyme-explorer/learning-center/collagenase-guide.html>. [Accessed: 09-Oct-2018].
- [4] Miltenyi Biotech. “Function and Benefits of gentleMACS C Tubes in Detail,” 2018. [Online]. Available: <https://www.miltenyibiotec.com/AT-en/resources/macs-handbook/macs-technologies/sample-preparation/sample-preparation.html> [Accessed: 9 Oct. 2018].
- [5] BD Biosciences. “Medicons,” 2015. [Online]. Available: <https://www.bdbiosciences.com/documents/Medimachine-System-Brochure.pdf> [Accessed: 9 Oct. 2018].
- [6] Qiu, X., De Jesus, J., Pennell, M., Troiani, M. and Haun, J., “Microfluidic device for mechanical dissociation of cancer cell aggregates into single cells,” *Lab Chip*. vol. 15, no. 1, p. 339-350, January 2015. [Online]. Available: <https://pubs.rsc.org/en/Content/ArticleLanding/2015/LC/C4LC01126K#!divAbstract> [Accessed: 9 Oct. 2018].
- [7] Worthington Biochemical Corporation, “Collagenase,” *Worthington Enzyme Manual*. 2018. [Online]. Available: <http://www.worthington-biochem.com/cls/default.html> [Accessed: 29 Sep. 2018].
- [8] Amini, H., Lee, W., and Carlo, D., “Inertial microfluidic physics,” *Lab on a Chip*, vol. 14, no. 15, p. 2741, 2014.
- [9] Mohrmanm, D., Heller, J., “The Peripheral Vascular System” *Cardiovascular Physiology*, 9e ed. New York: McGraw Hill, Educational/Medical, 2018.
- [10] Fan, R., Emery, T., Zhang, Y., Xia, Y., Sun, J., and Wan, J., “Circulatory shear flow alters the viability and proliferation of circulating colon cancer cells,” *Sci Rep*. vol. 6, June 2016. [Online]. Available: <https://www.nature.com/articles/srep27073> [Accessed: 3 Nov. 2018].
- [11] Ahmed, E., “Hydrogel: Preparation, characterization, and applications: A review,” *J Adv Res*. vol. 6, no. 2, p. 105-121, March 2015. [Online]. Available: <https://www.sciencedirect.com/science/article/pii/S2090123213000969> [Accessed: 8 Oct. 2018].

- [12] Kaklamani, G., Cheneler, D., Grover, L., Adams, M., and Bowen, J., “Mechanical properties of alginate hydrogels manufactured using external gelation,” *J Mech Behav Biomed Mater.* vol. 36, p. 135-142, August 2014. [Online]. Available: <https://www.sciencedirect.com/science/article/pii/S1751616114001222?via%3Dihub> [Accessed: 25 Nov. 2018].
- [13] Klemenz, A., Schwinger, C., Brandt, J., Koch, B., and Kressler, J., “Investigation of Elasto Mechanical Properties of Alginate by Ultrasound Methods,” *Ac Im.* vol. 26, p. 223-229, 2002. [Online]. Available: [https://link-springer-com.ezproxy.library.wisc.edu/chapter/10.1007/978-1-4419-8606-1\\_29](https://link-springer-com.ezproxy.library.wisc.edu/chapter/10.1007/978-1-4419-8606-1_29) [Accessed: 25 Nov. 2018].
- [14] Muiznieks, L. and Keeley, F., “Molecular assembly and mechanical properties of the extracellular matrix: A fibrous protein perspective,” *Biochim Biophys Acta.* vol. 1832, no. 7, p. 866-875, July 2013. [Online]. Available: <https://www.sciencedirect.com/science/article/pii/S0925443912002839> [Accessed: 11 Dec. 2018].
- [15] Lodish, H., Berk, A., Zipursky, S., Matsudaira, P., Baltimore, D., and Darnell, J., *Molecular Cell Biology. 4th edition.* New York: W. H. Freeman. 2000. Section 1.2

# Appendices

## Appendix I - Preliminary Design Specifications

### **Function:**

Extract Eosinophils from a small (1-2mm<sup>3</sup>), human lung sample to study the correlation between the presence of eosinophils in lung tissue and asthma. The device should extract approximately 10,000 cells for examination with flow cytometry.

### **Client Requirements:**

The device must have minimal disruption to the eosinophils to allow proper flow cytometry to be performed while still producing a sufficient sample of eosinophil separated from the remainder of cells in the tissue sample. The eosinophils must also be able to be properly identified using flow cytometry. The eosinophils are of primary concern and the other cell types can remain intact in the tissue as long as all the eosinophils are dissociated.

### **Design Requirements:**

#### **1. Physical and Operational Characteristics:**

- A. *Performance Requirements:* 50% (+/- 10%) of the total cellular mass must be recovered in a single cell suspension in order to be analyzed by flow cytometry. This will require that the cells are not lysed during the dissociation procedure. The device needs to be able to extract roughly 10,000 eosinophils through tissue dissociation of the lung sample. The device will need to be operational daily and subject to common sterilization techniques.
- B. *Accuracy and Reliability:* The device needs to extract enough cells for flow cytometry while also not altering cell surface markers or causing cell lysis. At least 10,000 eosinophils must be obtained after the use of the device.
- C. *Life in Service:* Non reusable option only need to last for one tissue dissociation. A reusable tissue dissociator will need to be reusable for approximately three years.
- D. *Operating Environment:* The device will be used in a common lab benchtop setting and will be subjected to various enzymes and sterilization products. The product may also be subject to a variety of temperatures depending on whether it is reusable or not.
- E. *Ergonomics:* Simplicity is the main goal of the ergonomic aspect of the device.
- F. *Size:* The device must be able to fit on a lab bench and be able to dissociate a tissue sample of an approximate size of 1-2 mm<sup>3</sup>.
- G. *Materials:* The materials used in the tissue dissociator must be biocompatible as not to interact with the tissue sample. A large component of the materials is that they must be cost effective as disposable devices must be less than \$10 per unit if they are to be considered disposable.



- H. *Aesthetics, Appearance, Finish:* Aesthetics and appearance are not a large factor in the making of this device. The device should generally be simple to cause as little confusion as possible as the functionality of the device is the main goal.

## 2. Production Characteristics

- A. *Quantity:* In initial testing only one prototype is required for testing. One device should be used per patient if it is not reusable. If the device is reusable, a fewer quantity will be needed. If chemical dissociation is used, each container should be used once.
- B. *Target Product Cost:* A budget for the full project is not defined. The target price of production for a disposable device is around \$10. The target price of production for a reusable device would be higher as the client can get more uses out of it. The exact number isn't established as it would depend on how many times the client would be able to reuse it.

## 3. Miscellaneous

- A. *Standards and Specifications:* This is a custom device being used in a specific research setting; there are no international or national standards to abide by.
- B. *Customer:* The client desires a way to recover any valuable human tissue should the device not be able to completely dissociate it as it is extremely difficult to procure these samples.
- C. *Patient-Related Concerns:* This device will be used in a research setting and the patient will not have contact with the device. No patient information will be retained in the device. The device will be sterilized after each use if reusable, or if device is one time use it will be disposed.
- D. *Competition:* As of now, there exists other devices that allow for tissue dissociation. However, these devices often require a large amount of tissue to be passed through them in order for the process to occur. The current Miltenyi tissue dissociator costs \$6.40 per sample tube [1]. Currently there are no devices on the market that are capable of taking in such a limited quantity of tissue and being able to completely dissociate it.

## References:

1. Miltenyibiotec.com. (2018). gentleMACS™ M Tubes - Miltenyi Biotec. [online] Available at: <https://www.miltenyibiotec.com/US-en/products/macs-sample-preparation/tissue-dissociators-and-tubes/c-tubes/gentlemacs-c-tubes.html> [Accessed 20 Sep. 2018].

## **Appendix II - Alginate Testing Protocol**

Alginate beads were synthesized in order to aid in the dissociation of a 1 mm<sup>3</sup> human lung tissue sample. The beads were placed inside of a specialized conical tube with the tissue sample to provide a further mechanical stimulation to the sample. This stimulation aided the dissociation and shortened the overall duration of the dissociation.

### **Materials:**

- Alginic Acid
- Deionized H<sub>2</sub>O
- HEPES
- CaCl<sub>2</sub>
- Stir Plate
- 500 ml beaker
- Transfer Pipette
- Bronchoscopy tool
- Lung tissue
- gentleMACS Tissue Dissociator
- gentleMACS enzyme kit
- gentleMACS conical tube
- 70 micron filter
- PBS
- Cytospin
- Microscope slides
- Staining dyes
- Centrifuge
- Hank's Buffer
- Hemocytometer
- Trypan Blue Dye

### **Protocol**

- Create a 1.25 wt% alginate solution by dissolving alginic acid in DI water
- Create the polymerizing solution in water with the following concentrations:
  - 400mM CaCl<sub>2</sub>
  - 10mM HEPES
- Using a bronchoscopy tool, remove tissue sample 1 mm<sup>3</sup> in volume
- Weigh the sample of tissue prior to any other steps
- Prepare enzyme kit by following these steps:
  - 120 μL 20x of buffer S into 2.28 mL of PBS
  - 100 μL Enzyme D
  - 15 μL Enzyme A
- Soak 4 tissue samples in enzyme solution for 20 minutes
- Measure out 4.4 g of the hydrogel beads and add them, the enzyme solution, and the tissue sample to the gentleMACS conical tube
- Put the conical tube into the gentleMACS dissociator and set it to the Lung setting

- After the machine has been run, filter the resulting mixture using a 70 micron filter
- Mixture can be washed using PBS to remove mixture from conical tube
- Take 15  $\mu\text{L}$  of solution and prepare it for the hemocytometer
- Run the rest of the solution through the cytopspin

### **Cytospin Protocol**

- Centrifuge solution, aspirate liquid to isolate cell pellet
- Resuspend the cell pellet in Hank's Buffer
- Put the resuspended liquid into Cytospin
- Run the Cytospin to generate microscope slides
- Stain the resulting microscope slides to look for cell survival

### **Hemocytometer Protocol**

- Stain the resulting mixture with trypan blue dye with the proper ratio
- Add this stained mixture to the hemocytometer and allow it count the number of cells that are present

### **Appendix III - Statistical Analysis**

#### **t-Test: Two-Sample (Total Cell Count)**

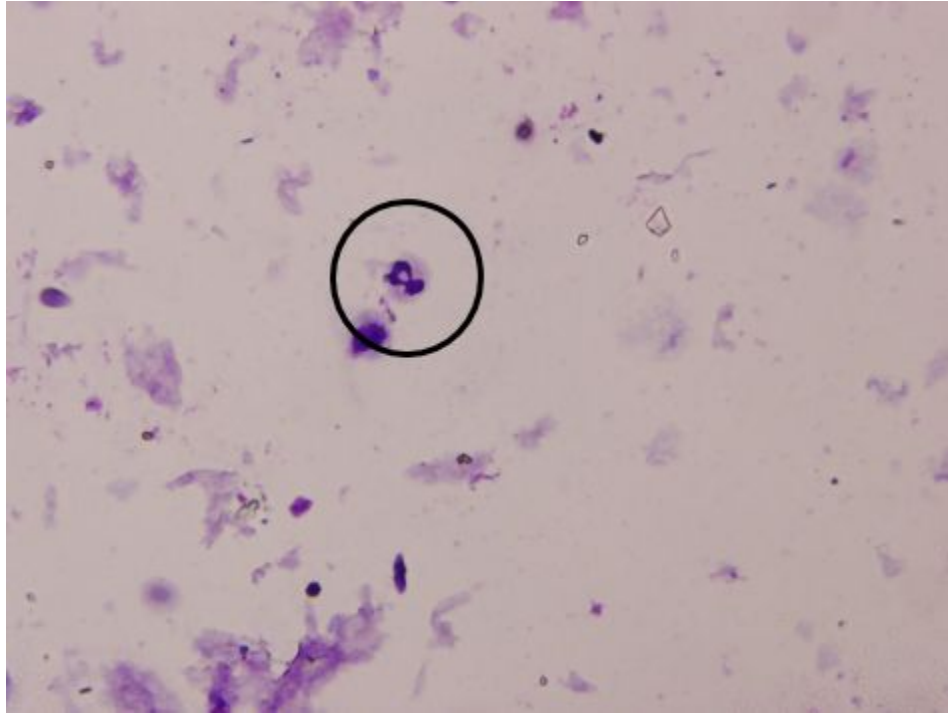
	<b><u>Experimental</u></b>	<b><u>Control</u></b>
Mean	45	8
Variance	441	48
Observations	3	3
Pearson Correlation	-0.371153744	
Hypothesized Mean Difference	0	
df	2	
t Stat	2.622860459	
P(T<=t) one-tail	0.049897887	
t Critical one-tail	2.91998558	
P(T<=t) two-tail	0.119795774	
t Critical two-tail	4.30265273	

#### **t-Test: Two-Sample (Alive Cell Count)**

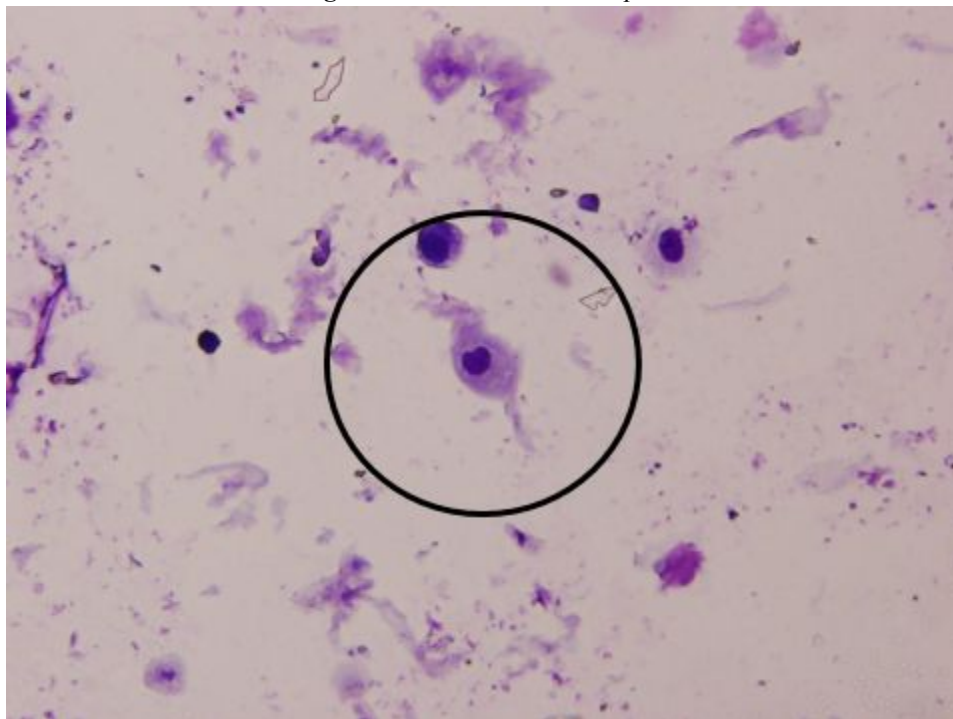
	<b><u>Experimental</u></b>	<b><u>Control</u></b>
Mean	45	2.666666667
Variance	441	5.333333333
Observations	3	3
Pearson Correlation	-0.989743319	
Hypothesized Mean Difference	0	
df	2	
t Stat	3.148545288	
P(T<=t) one-tail	0.043896686	
t Critical one-tail	2.91998558	
P(T<=t) two-tail	0.087793373	
t Critical two-tail	4.30265273	

## **Appendix IV - Pictures of Microscope Slides**

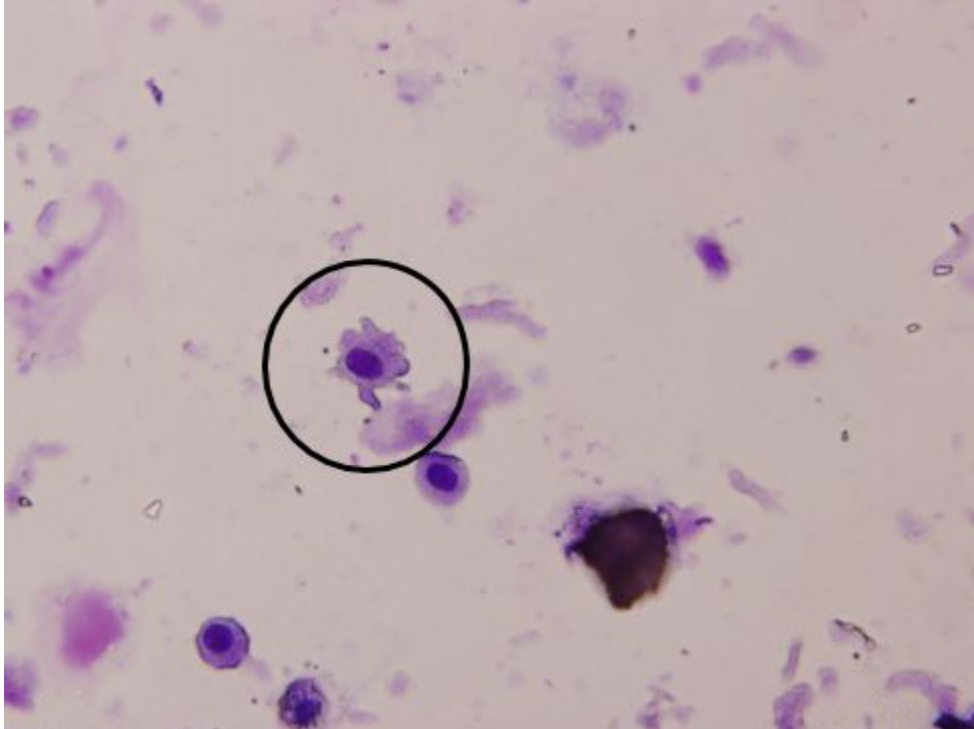
All of the pictures taken are from one microscope slide from the dissociation method with hydrogel beads.



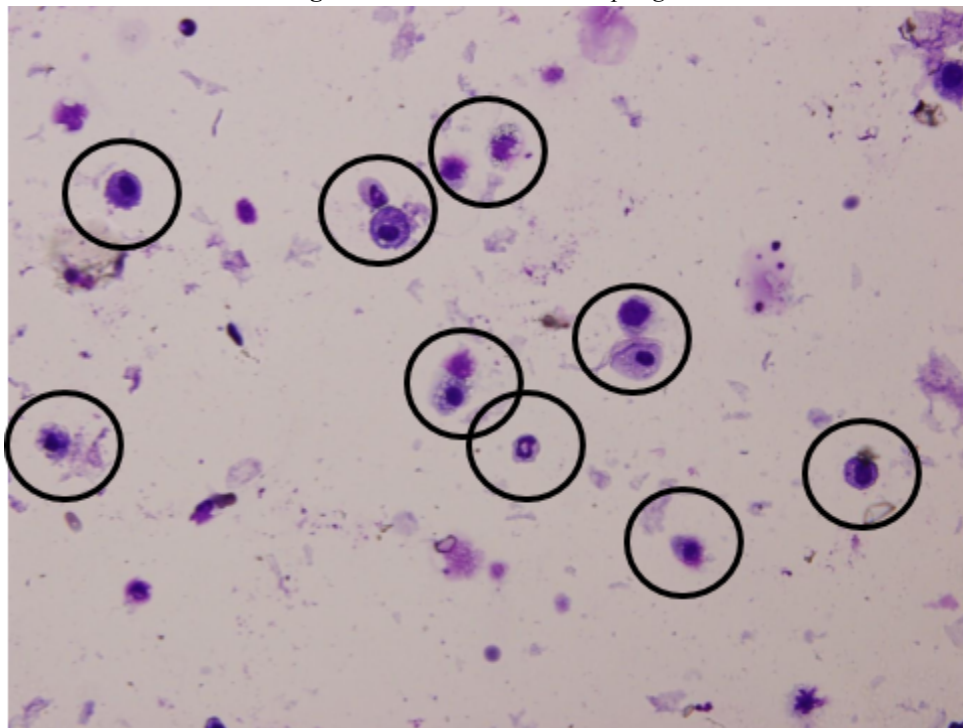
**Figure 15:** *Dissociated neutrophil*



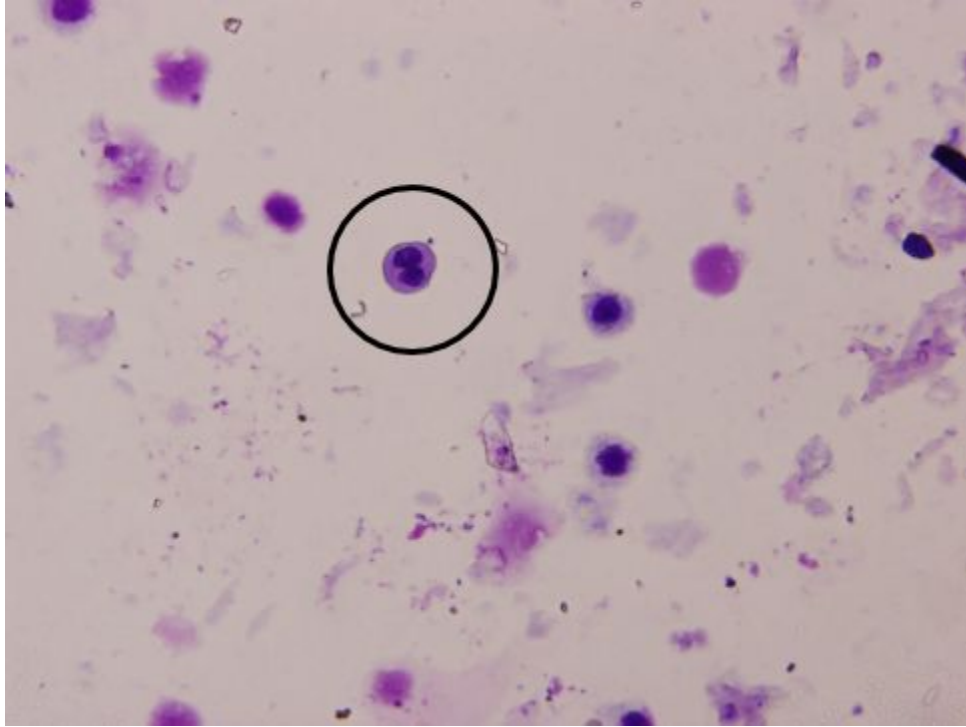
**Figure 16:** *Dissociated epithelial cell*



**Figure 17:** *Dissociated Macrophage.*



**Figure 18:** *Many kinds of cells that were dissociated*



**Figure 19:** *Possibly an eosinophil that was dissociated*

**Appendix V- Materials Purchased**

<b>Date:</b>	<b>Item:</b>	<b>Cost:</b>	<b>Comments:</b>
10/24/2018	Sodium, Alginate	\$31.59	
11/8/2018	Irgacure 2959	\$48.25	Curing Agent for the PEGMMA
11/8/2018	PEGMMA 1000	\$33.00	
<b>TOTAL</b>		<b>\$112.84</b>	