

Problem Statement

A device is needed to allow dual sequential defibrillation (DSD) to be executed on patients in refractory ventricular fibrillation (RVF) using one defibrillation monitor and be compatible with the Lund University Cardiopulmonary Assist System (LUCAS) device.

Motivation/Background

- RVF: heart's failure to return to normal rhythm despite 3 standard defibrillation attempts [1] with a mortality rate of 85-97% [2]
- In DSD, two shocks of electrical current are sent through the heart sequentially through two sets of pads to increase myocardial cell response [1][3]

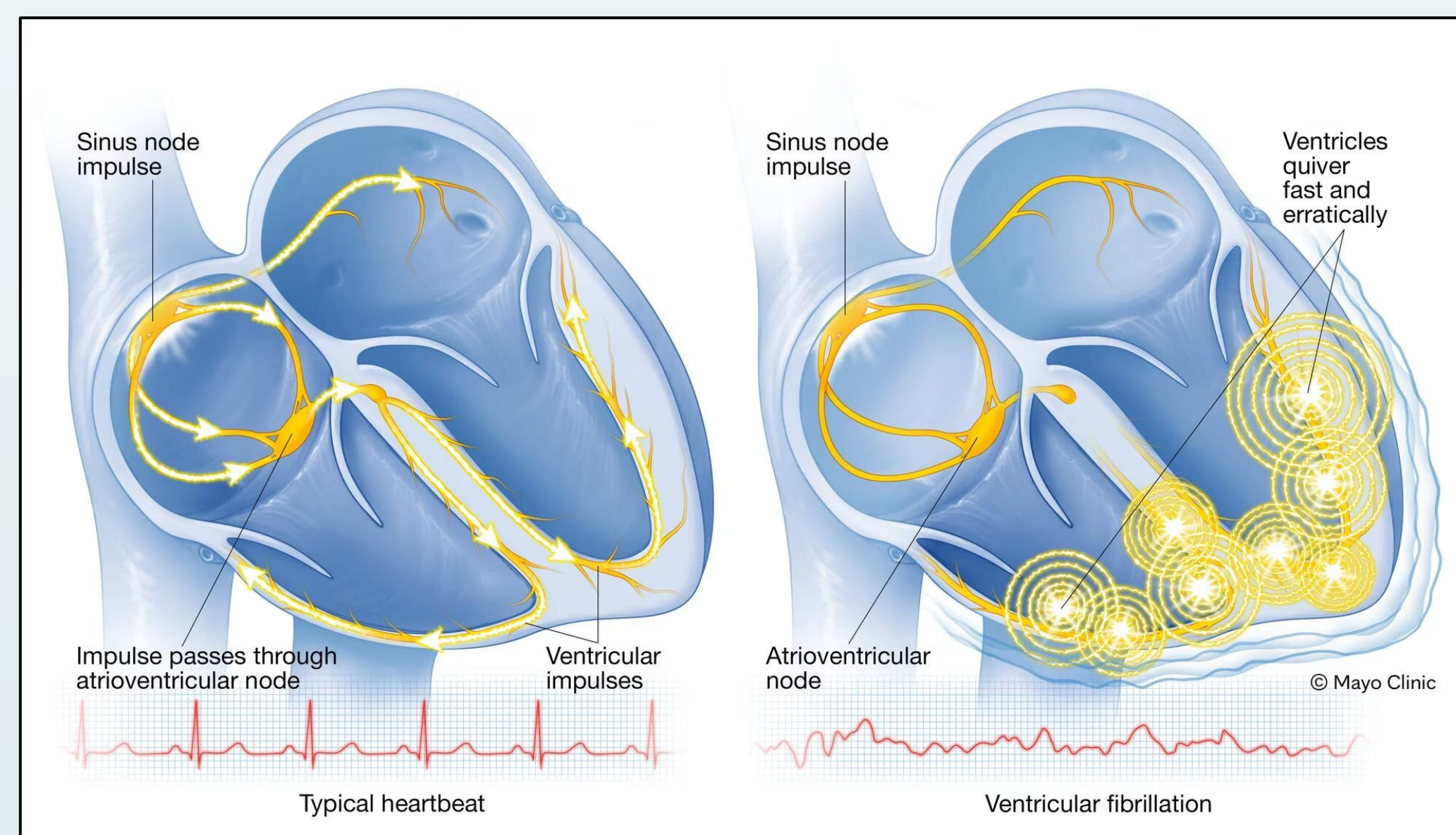

Figure 1: Diagram showing electrical signals in a standard heart rhythm and RVF along with the associated ECGs [4]

- Established medical intervention for RVF:
 - Quality cardiopulmonary resuscitation (CPR)
 - 120-200 J shocks deliver by defibrillator [5]
- Impedance is the resistance of the body to electrical current
- Challenges to testing and performing DSD:
 - Use is rare: 1 in 200,000 cardiac arrests are RVF [2]
 - Pad placement cannot interfere with the LUCAS device
 - High cost to perform DSD as 2 monitors required
- Addressing DSD challenges could lead to better understanding of its effectiveness [6]

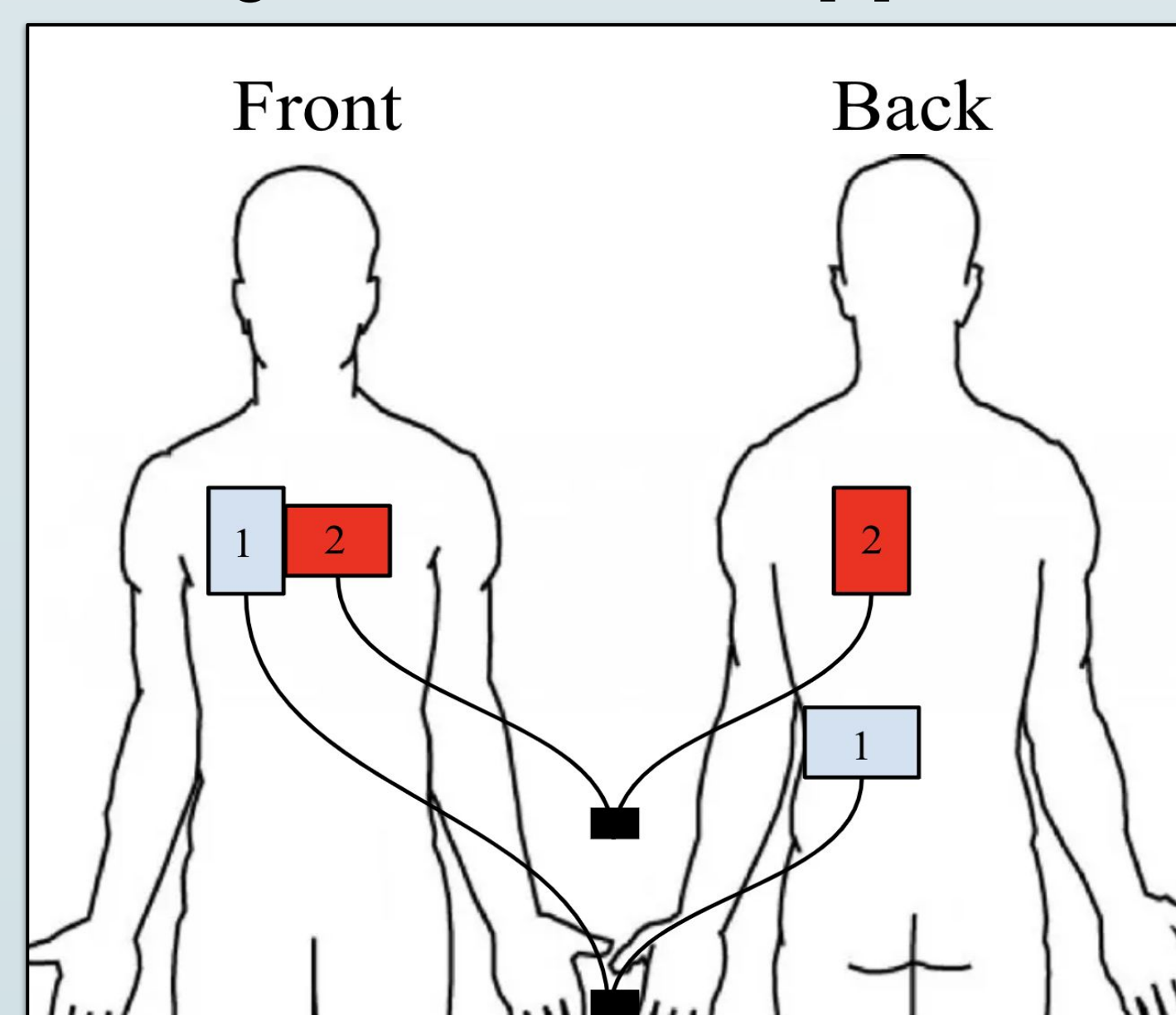

Figure 2: Diagram of pad placement for DSD

Design Criteria

- Deliver 180 J of energy each through two separate vectors
- Each shock delivered within 0.5 seconds apart [7]
- Allow maximum of 2600 V and 30 A to pass through
- Budget of \$500
- 96% of shock delivered is received [8]
- Meet IEC 60601-2-4:2010 Medical electrical equipment - part 2-4 requirements [9]
- No interference with impedance calculations from monitor
- Compatible with biphasic shocks

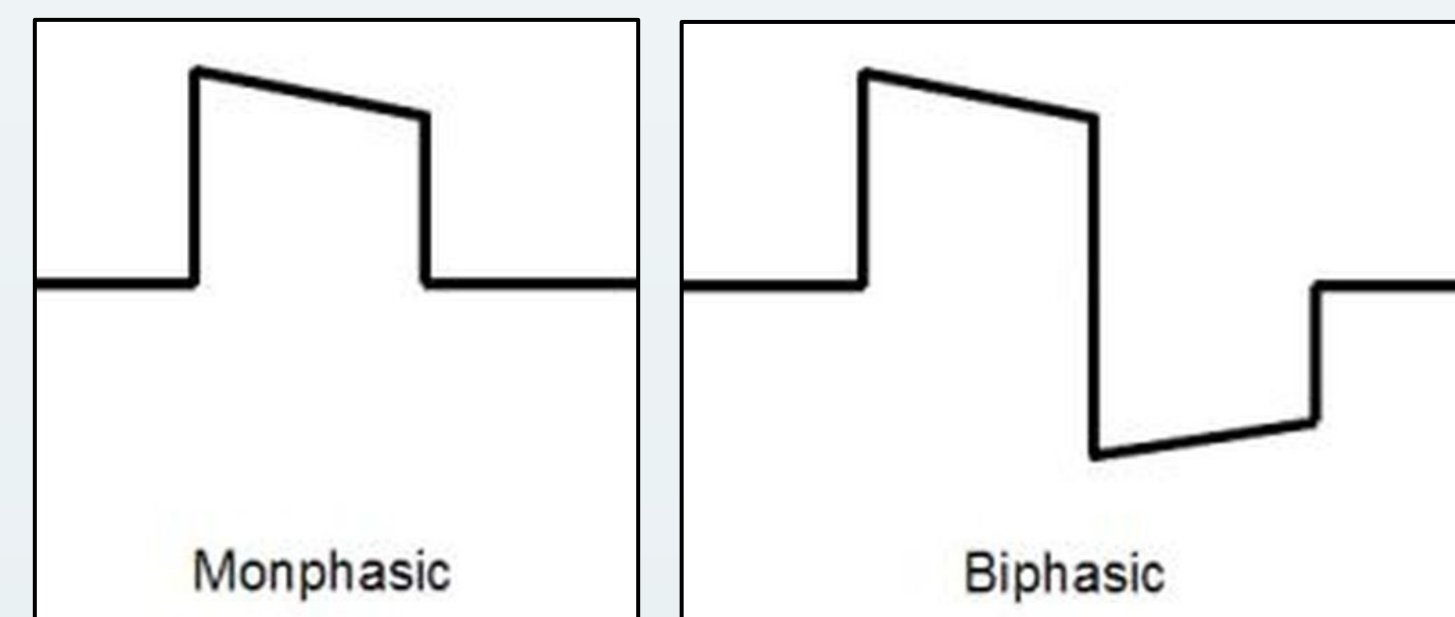

Figure 3: Monophasic and Biphasic Shock Wave [10]

Results and Discussion

Switch Test

Goal: Determine if switch will arc current under high voltages

- Tested under 1000 V, 2000 V, and 2600 V DC
- 5, 2 second long trials for each voltage
- Only 0.0005% of current in circuit will arc through an open switch, based on equation from Figure 6
- No variation in arc magnitude across trials for each voltage

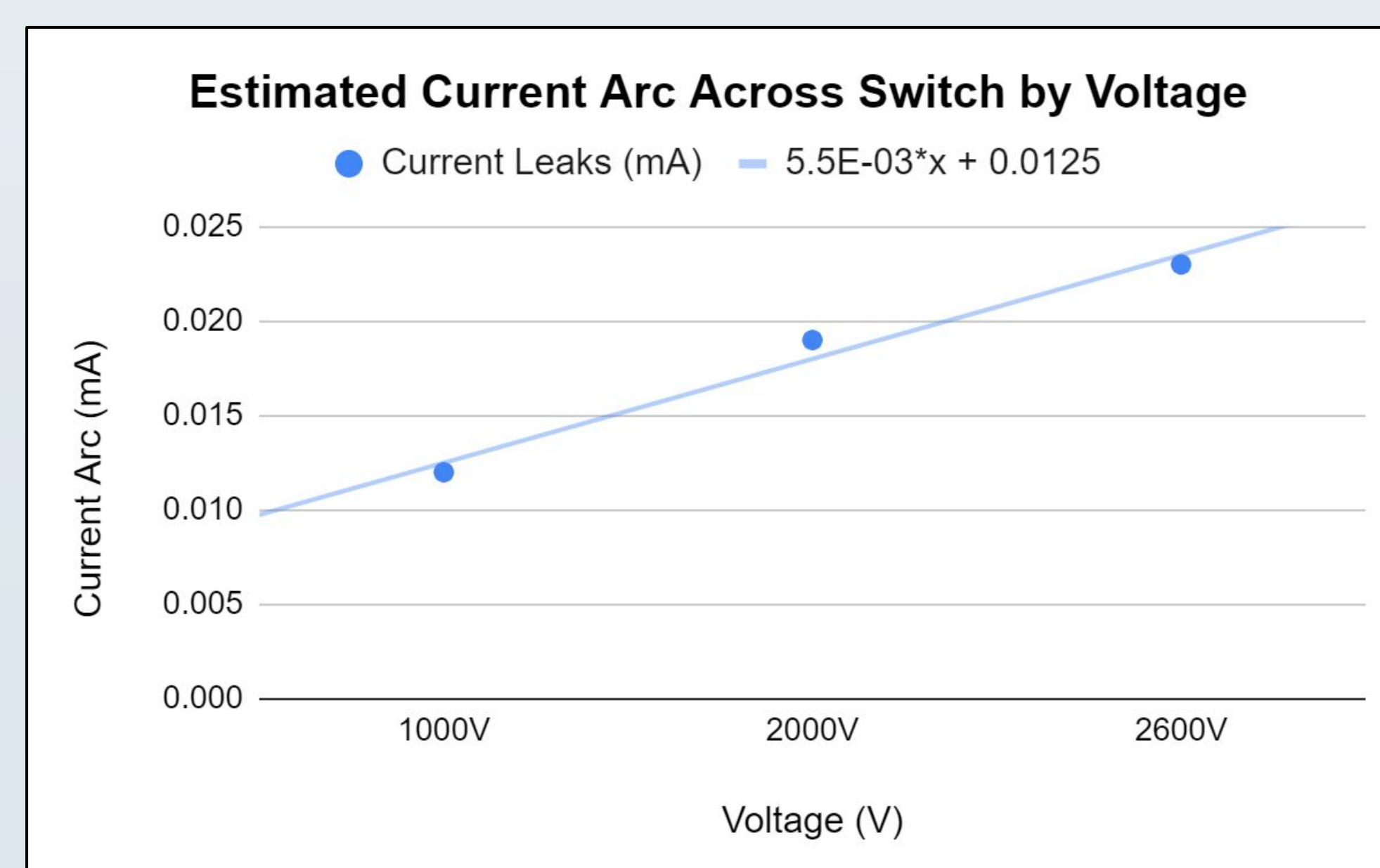

Figure 6: Magnitude of Current Arc

DSD Functionality Test

Goal: Determine if polarity of voltage impact output at vectors

- Measured voltage at both pads at -5 V to 5 V with 1 V step
- For all test voltages, measured voltage was less than expected voltage, but magnitude of difference did not scale with input
- At voltages tested, the difference is significant with p value decreasing with increasing voltage
(1 V p = 3.6E-160 and 5 V p = 5.5E-16)
- Hypothesize that difference is due to diode resistance
- Voltage difference will be insignificant at high voltages
- Vector 1 and 2 passed only positive or negative voltages respectively (Figure 8)

Final Design

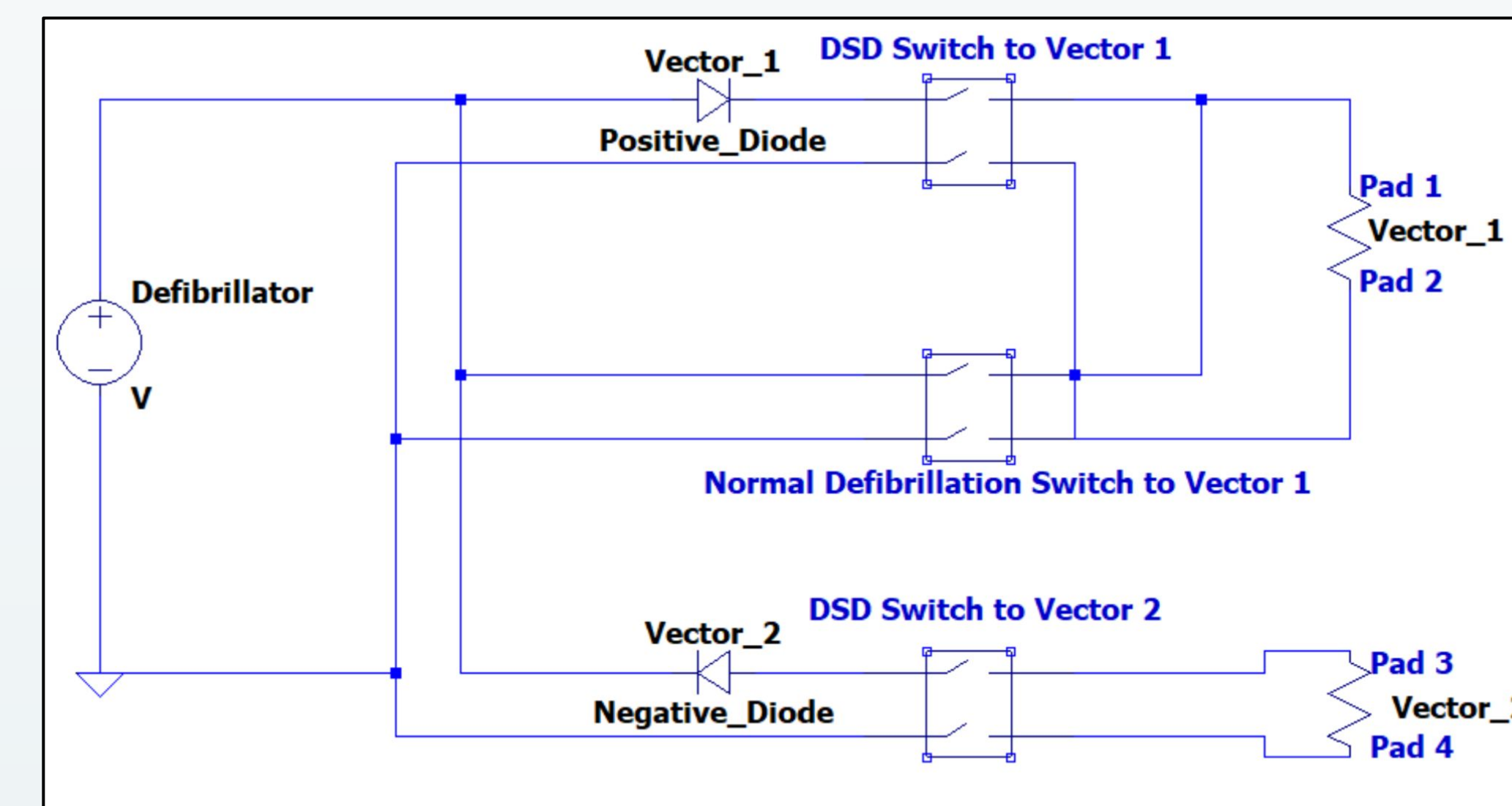

Figure 4: Final Circuit Design

- Normal Defibrillation switch ON the diode circuit bypassed
- DSD switches ON the diodes redirect current and allow positive or negative current to flow depending on the vector
- Diodes create the 2 sequential shocks

Connectivity and Impedance Test

Goal: Test connections and ability of monitor to read impedance

- A 150 J shock sent to manikin through device
- Manikin received 175 J
- No difference in received shock with device compared to standard defibrillation, proves connections are sufficient
- Increase in received shock proves impedance not altered by device

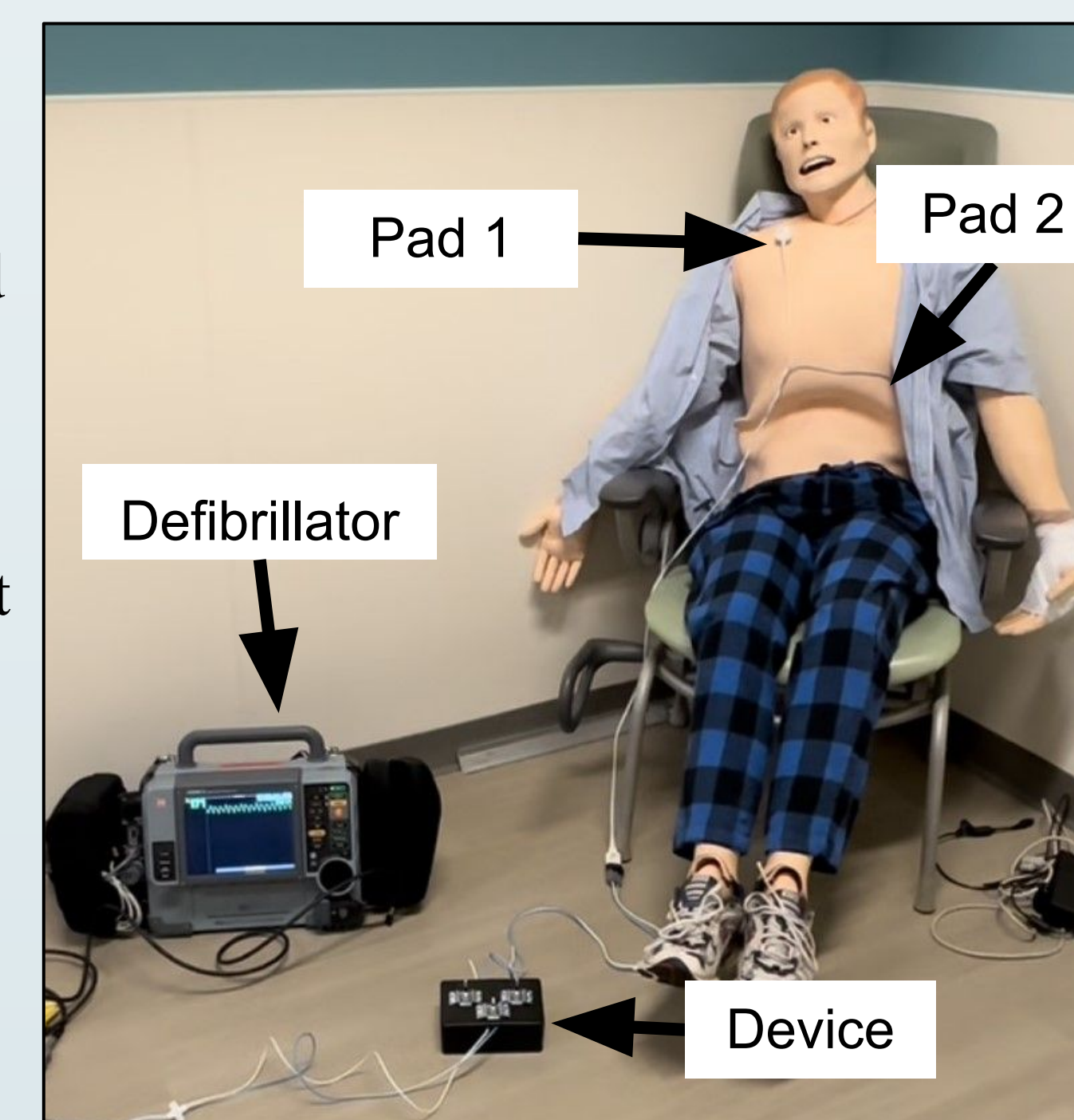

Figure 7: Defibrillator with Device and Manikin Configuration

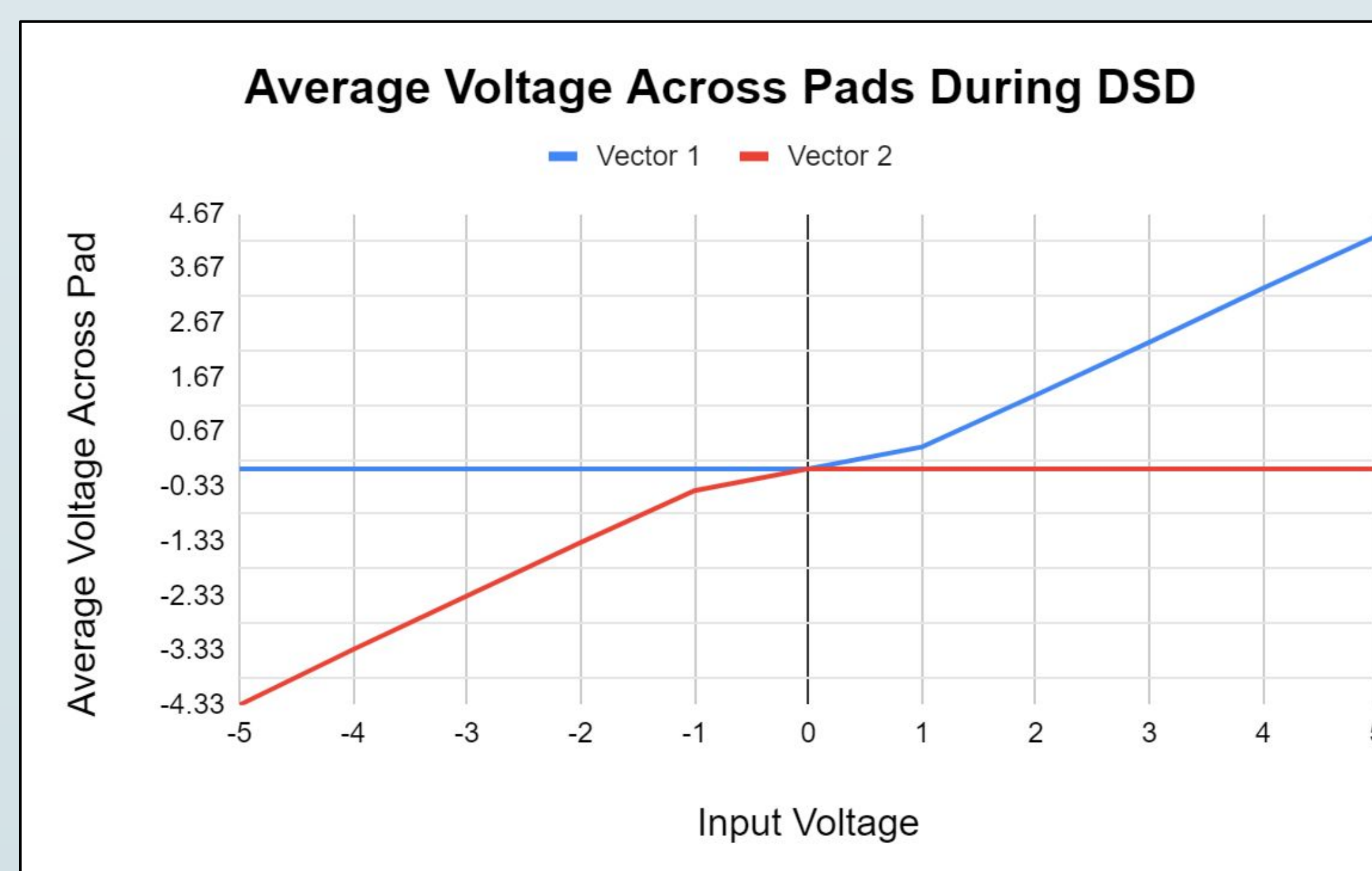

Figure 8: Polarity of Voltage Across Both Vectors

- 3 switches to control DSD and standard use
- Connects 1 monitor with 2 sets of cardiac pads
- Distributes 360 J shock across 2 vectors (180 J each)
- Both shocks delivered sequentially with total time less than 16 milliseconds
- Compatible with LIFEPAK and Zoll cardiac pads and LIFEPAK 15 Monitor
- Can withstand ~2600 V and ~30 A the LIFEPAK 15 outputs during a 360 J defibrillation shock

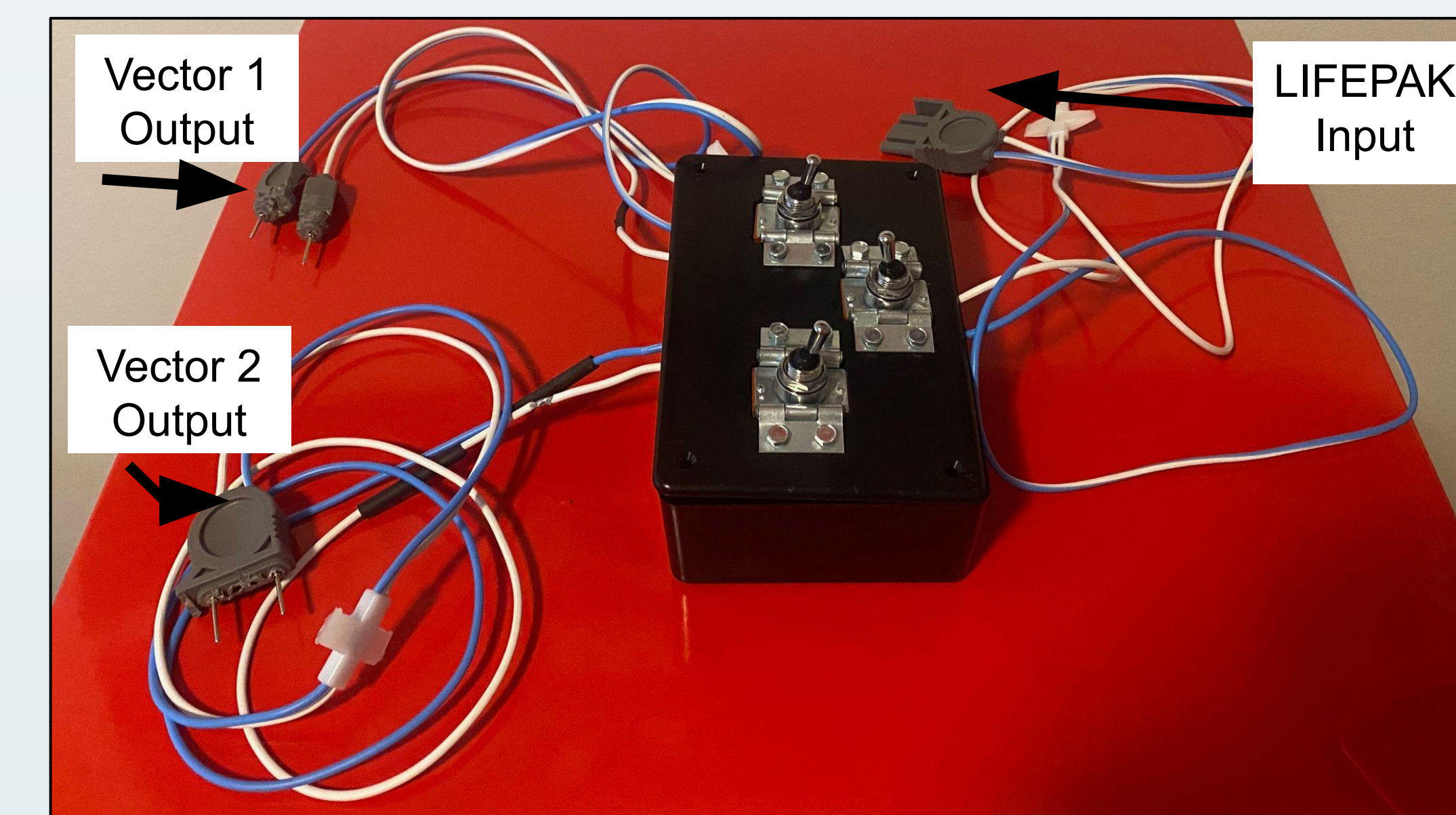

Figure 5: DSD Device with labels

Future Work

- Turn three switch system into two switch system, one for DSD and one for vector change
- Resolder circuit to include vector change
- Create two H-Bridges to transform the two monophasic shocks into two biphasic shocks
- More user friendly interface with switches and adaptor plugs

Acknowledgements

BME Department
Dr. Michael Lohmeier
Dr. John Puccinelli
Tyler Ross

Dr. Amit Nimunkar
Mitchel Reuter
Pia Strampp
Makerspace Staff

References

- E. M. Simon and K. Tanaka, "Double Sequential Defibrillation," *Cardiology Clinics*, vol. 36, no. 3, pp. 387-393, 2018. doi:10.1016/j.ccl.2018.03.006
- A. Mohammed et al., "Refractory Ventricular Fibrillation in Traumatic Cardiac Arrest: A Case Report and Review of the Literature," *National Library of Medicine*.
- M. Ramzy and P. G. Hughes, "Double Defibrillation," *National Library of Medicine*, Apr.2023.
- "Ventricular fibrillation," *Mayo Clinic*, https://www.mayoclinic.org/diseases-conditions/ventricular-fibrillation/symptoms-causes/syc-20364523
- Ventricular fibrillation - statpearls - NCBI bookshelf, https://www.ncbi.nlm.nih.gov/books/NBK537120/
- C. C. medical professional, "What is defibrillation used for?," *Cleveland Clinic*, https://my.clevelandclinic.org/health/treatments/23021-defibrillation
- Hoch DH;Batsford WP;Greenberg SM;McPherson CM;Rosenfeld LE;Marieb M;Levine JH, "Double sequential external shocks for refractory ventricular fibrillation," *Journal of the American College of Cardiology*, https://pubmed.ncbi.nlm.nih.gov/8144780/
- B. J. Cross and M. S. Link, "Erroneous shock by an AED: Importance of obtaining AED tracing to prevent inappropriate ICD implantation," *HeartRhythm case reports*, https://www.ncbi.nlm.nih.gov/pmc/articles/PMC5418544
- V. Padmavathi, P. Kundra, P. Vishnu Prasad, and T. Siva, "Defibrillator maintenance policy," *Indian Journal of Anaesthesia*, vol. 59, no. 10, p. 685, 2015. doi: https://doi.org/10.4103/0019-5049.167478.
- J. Francis, ECG Quiz 24 Dec 12, About The Author Johnson Francis, Former Professor of Cardiology, and J. F. P. of Cardiology, "All about cardiovascular system and disorders," *All About Cardiovascular System and Disorders*, https://johnsonfrancis.org/professional/difference-between-a-monophasic-and-biphasic-defibrillator/