



## PRELIMINARY REPORT: FORCE SENSOR FOR ROWING BIOMECHANICS

---

October 11th, 2023

*BME 300/200*

**Clients: Dr. Jill Thein-Nissenbaum, Ms. Tricia De Souza, Ms. Sarah Navin**

**Advisor: Dr. Brockman**

Team Members:

Team Leader: Neha Kulkarni

Communicator: Simerjot Kaur

BWIG: Orla Ryan

BWIG: Bryan Topercer

BPAG: Simret Bhatia

BSAC: Emily Wadzinski

# Abstract

Elite rowers that engage in a high volume of training can suffer from a variety of injuries, the most common occurring in the lumbar spine [1]. As rowing is a full-body movement, perfecting technique and maintaining proper form is essential to preventing such injuries and improving performance overall [2]. The UW-Madison women's rowing team is seeking a way to measure real-time biomechanical data in the form of approximate foot force in order to determine the presence of any bodily asymmetries and correct athletes' form. Existing products such as the BioRow Force Plates, often involve expensive and highly advanced equipment such as small, accurate load cell sensors [3]. In order to achieve a more affordable solution that still maintains an appropriate level of accuracy and does not disrupt users' rowing technique, several designs with cheaper alternatives to market-brand force cells were considered. The preliminary design that was deemed most suitable, the Force-Sensitive Resistor, consists of a circuit-based sensor system that is predicted to be seamless and an accurate assessor of force magnitude [4]. Through use of an Arduino microprocessor which will connect a laptop for display, results will be presented to users in a straightforward manner. Upon completion of a working prototype and implementation into the necessary environment, testing will be performed to evaluate the device's capabilities and performance, after which the design will either be revised or finalized.

# Table of Contents

<b>Abstract</b>	<b>1</b>
<b>Table of Contents</b>	<b>2</b>
<b>I. Introduction</b>	<b>3</b>
Motivation	3
Current Methods and Existing Devices	3
Problem Statement	4
<b>II. Background</b>	<b>5</b>
Relevant Physiology and Biology	5
Relevant Design Information	5
Client Information	8
Design Specifications	8
<b>III. Preliminary Designs</b>	<b>9</b>
Force-Sensitive Resistor	9
Silicone-Magnetic Force Sensor	10
Miniature Compression Load Cells	11
<b>IV. Preliminary Design Evaluation</b>	<b>12</b>
Design Matrix	12
Design Evaluations	14
Proposed Final Design	18
<b>V. Fabrication/Development Process</b>	<b>18</b>
Materials	18
Methods	19
Final Prototype	20
Testing	20
<b>VI. Results</b>	<b>21</b>
<b>VII. Discussion</b>	<b>21</b>
<b>VIII. Conclusions</b>	<b>23</b>
<b>IX. References</b>	<b>24</b>
<b>X. Appendix</b>	<b>25</b>
Appendix A: Product Design Specifications	25
Appendix B: Materials and Expenses	33

# I. Introduction

## Motivation

Many members of the University of Wisconsin Women's Rowing team have been dealing with lower back pain and other injuries, possibly due to asymmetric force output while rowing. Rotational twisting at the hips and torso are the lead causes for back pain in rowers, but is currently only qualitatively studied by the University of Wisconsin personal trainers [5]. Many rowers experience back injury due to various reasons: consistently exerting force when the back is flexed, repetition of the rowing movement, and not properly adapting to the size of the ergometer or boat [6]. However, current methods do not involve a way to quantitatively assess asymmetry in rowers. The Women's Rowing coaching staff is looking for a device to measure the force output female collegiate athletes produce while rowing. With this device, the athletic training staff hopes to be able to interpret differences in symmetry of a rower's force output, fix their form, and potentially reduce the risk of lower back injury by looking at quantitative values, rather than one-on-one observations.

## Current Methods and Existing Devices

The University of Wisconsin Women's Rowing team currently uses an ergometer and one-on-one visual coaching and analysis to critique form and look for potential injury risks. Their current data is all qualitative, and uses the judgment of a trainer or coach to make observations and correct form. The ergometer is a symmetrical rowing device, and is much different from the natural rowing movement on water, which can be asymmetrical. The combination of only qualitative data and a machine that does not accurately represent actual rowing creates the need for a new device that can quantitatively measure rowing performance and asymmetry, in a location where a more natural rowing movement is used.

The Concept2 RowErg, which is the ergometer used by the UW Rowing Team, displays a Force Curve that is used by rowers to track their force throughout a stroke. This design uses an

ergometer that displays a live force-time curve and provides feedback by showing certain graph shapes. However, this design focuses on force output through the handle, not the lower extremities [7]. This device helps athletes compare their real time force output to reference graphs which help understand the flaws in their form.

To track lower extremity forces, the BioRow 2D Force Stretcher, produced by BioRow Ltd., is a plate affixed to the foot stretcher of an ergometer. The plate has load cells attached to it with strain gauges that measure force in horizontal and vertical directions. The plate contains four load cells, two for each foot, placed on the heel and the toe locations [3]. These load cells are capable of measuring high force outputs in rowers, and can assist personal trainers and coaches with critiquing a rower's form.

The Bertec Force Plates are also capable of sensing forces from lower extremities; specifically, they sense ground reaction forces during gait, balance, and performance analysis. They contain load cells that sample at a rate of 100 Hz, and can sense force in three directions. These force plates have large load capacities ranging from around 4500 N to 17,800 N, and come in a permanent model which can be fixed to the floor, or a portable model. Bertec also produces custom electronics and software which are both used to process the raw data from the force plates [8]. Though they are the lab and industry standard, these force plates cannot be modified in any way in terms of size or configuration to fit an ergometer.

## Problem Statement

Many college rowing athletes, particularly women, are susceptible to lifelong lower back or hip injuries due to disparate weight distributions on each leg while rowing. This issue can be addressed through gathering real-time data on athlete biomechanics, but this data is often difficult to obtain. Collection and analysis of biomechanical data will enable athletes to adapt their technique towards better performance, and will assist coaches and trainers in preventing injury. The client, Dr. Jill Thein-Nissenbaum, has tasked the team with creating a force plate system that can collect biomechanical data from rowers' lower extremities. The team's goal is to create a wireless sensor system in the rowboat that will capture load distribution during time of use and will assess lower extremity asymmetry to establish risk stratification. Additionally, the team aims to translate the force plate system into a user-friendly interface that will enable

coaches and athletes to understand essential biofeedback information, thereby improving both performance and safeguarding against potential injuries.

## II. Background

### Relevant Physiology and Biology

Rowing is a very high impact, fast-paced, and technical sport. Without extreme care, it is easy to get injured. Rowing requires a high magnitude of force from the entire body, but especially from the legs. There are four phases of the rowing stroke: the catch, the drive, the finish, and the recovery. During the catch phase, the rower's oars are fully in water, and their hips, knees, and ankles are in full flexion. The rower then moves into the drive phase, the rower extends their hips, knees, and ankles forcefully to propel the oar. During this phase, the upper body is braced so force can be transferred from the legs to the oars. During the finish, the rower is in full extension in their lower extremities and their elbows are in full flexion as they have completed the full range of motion required to move the oar. The recovery phase is the return to full flexion as the rower prepares to start the cycle of catch, drive, finish and recovery again [1].

The forces involved in the upper body can cause the spine to rotate as rowers typically only hold one oar on one side of their body in sweep rowing. This creates torque in the upper body as the spine twists to help pull and the push oar. The lumbar spine only allows for about 1.2 to 1.7 degrees of rotational movement, but most rotation happens in the mid spine causing stress on the lumbar spine leading to back pain [10]. As a result, the most commonly cited injuries in rowers are those of the lumbar spine [11].

### Relevant Design Information

Rowing involves precise movements of the entire body. As a result, there are multiple forms of rowing. The two main forms of rowing are sculling and sweeping. Sculling is symmetric as rowers hold onto one handle of the oar in each hand directly in front of them and are able to pull straight back without having to twist. This form is mimicked in an ergometer.

The second form, sweeping, is done on one side of the body and each rower has only one oar to manipulate. This is an asymmetric form of rowing that causes rowers to twist their upper body as they row. This form of rowing is done in a boat or tank. Boats have several configurations, and are known as “shells” for competitive racing. There is a four-person shell that allows for each rower to have control over two oars, mimicking sculling. There are two configurations for sweeping; one is in a four-person shell and the other is in an eight-person shell. These configurations are pictured in Figure 1.

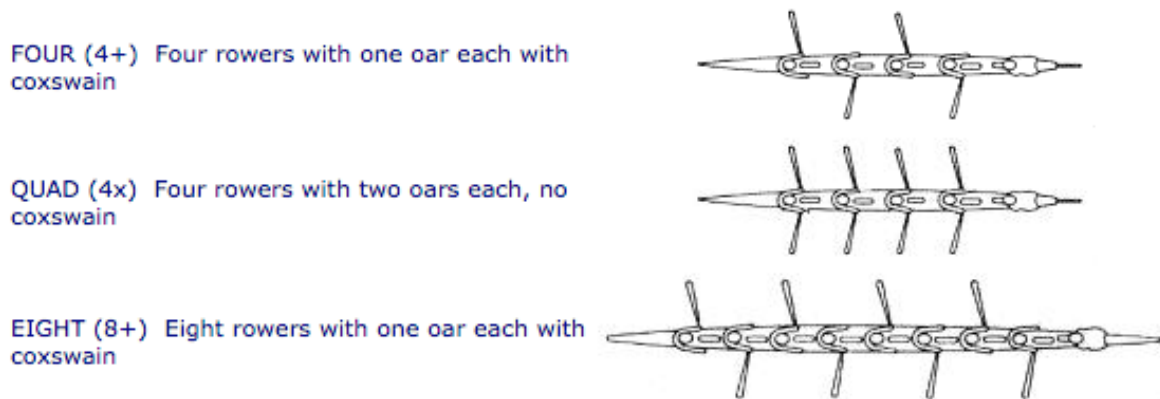

Figure 1. Configurations of boats for competition rowing.

The prospective design must be installed into a device or environment that closely mimics that of rowing on the water. Understanding a rower’s movement is crucial to understanding the design ideas and constraints to ensure that the device does not impede a rower’s technique. The UW Boathouse has a rowing tank, which is able to mimic the current of water as well as provide rowers with seating, oars, and overall environment similar to rowing while still being a controlled environment where conditions cannot change very quickly and suddenly. Coaches and rowers generally use this tank for form and technique correction. The tank houses 12 bases of the Concept2 RowErg lined up in a row to simulate a boat configuration, as shown in Figure 1. Figure 2 shows the footplate on the ergometer, which features a detachable heel portion that allows for rowers to disconnect from the footplate and gain momentum when pulling back on the oar. Additionally, foot straps keep the rower’s forefoot attached to the footplate allowing the rower to pull back in using force generated from the front of the foot. The seat can freely move up and down along a bar, permitting the rower full extension of their legs.



Figure 2. Concept2 RowErgs configured in the tank at the UW Boathouse.



Figure 3. Footplate of a Concept2 RowErg.



## Client Information

The clients that the team is working with include Dr. Jill Thein-Nissenbaum, Ms. Tricia De Souza, and Ms. Sarah Navin. All three work with and are representing the University of Wisconsin-Madison (UW-Madison) Women's Rowing Team. Dr. Jill Thein-Nissenbaum is a professor in the UW Madison Physical Therapy Program, and is the staff physical therapist for Badger Sports Medicine. She provides consultation and rehabilitation services for all UW Madison sports and works in the Badger Athletic Performance Center analyzing athletic testing performed on UW Madison athletes [12]. Ms. De Souza is a UW-Madison Athletic Trainer; in particular, she provides athletic training services for both the Badgers Men's and Women's Rowing Teams [13]. Finally, Ms. Sarah Navin is a UW Madison Physical Therapy student. She attended UW Madison for undergraduate school and was previously on the Badger Women's Rowing team.

## Design Specifications

This product has several specifications that will determine how fabrication and design is approached. Most importantly, the product must be compatible with the Concept2 RowErg, as this is the ergometer used by the rowing team during indoor practices. This will entail taking certain dimensions into consideration, such as the ergometer's 61 centimeter width [14]. The device must not impede normal rowing motions, so it should not noticeably affect the shape of the ergometer. The main goal of the design is to provide real-time, relatively accurate measurements of rowers' magnitude of force so that any asymmetries can be corrected in the moment. As such, the force magnitude must be measured within a limited margin of error of 5% [15]. The product should be engineered to last a service life of around 10-12 years, approximately the length of an average rower's career [16]. Due to the year-round practice season for UW Madison rowers, as well as the wide temperature range experienced in Madison, Wisconsin, the product must withstand temperatures from around 8.3 degrees Celsius to 22.2 degrees Celsius [17]. The product should also be reproducible, with the end goal of interpreting data from 8 rowers in a boat at once. The full Product Design Specifications are outlined in Appendix A.

### III. Preliminary Designs

#### Force-Sensitive Resistor

The Force-Sensitive Resistor design utilizes a Force-Sensitive Resistor (FSR), which decreases in resistance when compression is applied. As the resistor is compressed, more conductive elements within the FSR make contact with wires, which increases the electrical output. FSRs have a simple construction which makes them a cost-effective and accurate way to measure force magnitude [4]. The FSR design consists of four FSRs, with two mounted on each footplate of the ergometer to measure toe and heel forces throughout a stroke, as shown in Figure 4. The exact configuration of the FSR circuit is yet to be determined in testing; however, the team aims to begin with a voltage divider circuit as shown in Figure 5. The analog output voltage from the voltage divider will be processed by an Arduino. From an output voltage, the Arduino can calculate the resistance in the FSR using (1), which can be correlated to the force applied to the FSR by using a Force-Resistance curve provided by the manufacturer of the FSR in use. The Force-Resistance curve will resemble that of Figure 6. A laptop connected to the Arduino will display the force magnitude in real-time as it is calculated.

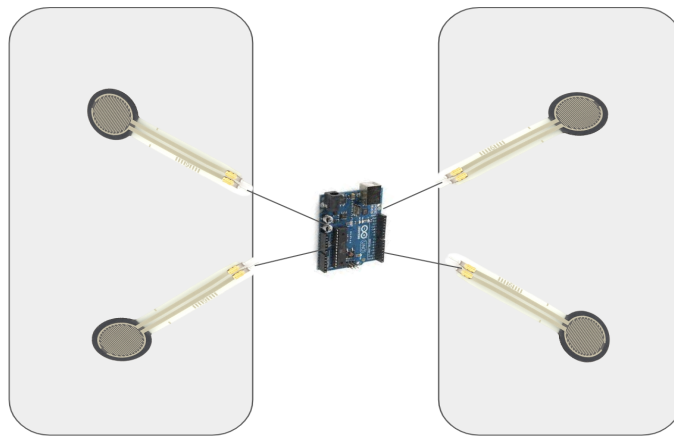

Figure 4. A schematic of the Force-Sensitive Resistor Design.

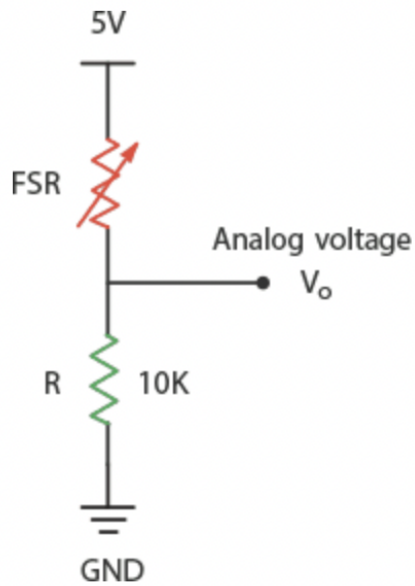

Figure 5. Example voltage divider circuit containing FSR [18].

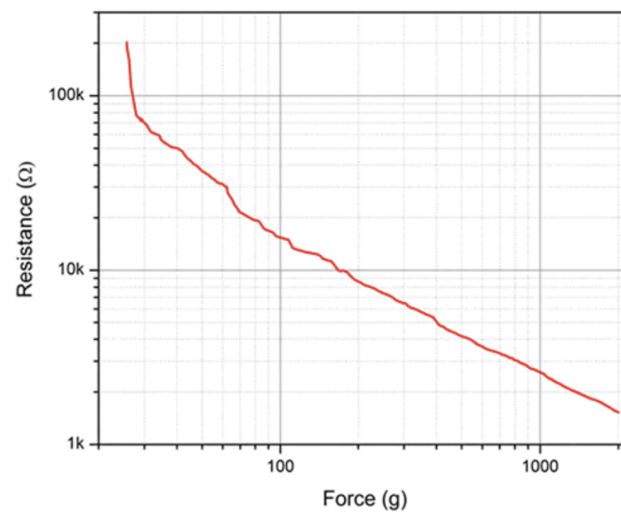

Figure 6. Example Force-Resistance Curve for an FSR [18].

$$V_o = V_{CC} \left( R \div (R + FSR) \right) \quad (1)$$

## Silicone-Magnetic Force Sensor

The Silicone-Magnetic Force Sensor preliminary design is centered around a set of handmade force sensors; that is, fabrication of said sensors would be completed by the team. These small sensors would gather data through the Hall effect, by both generating a magnetic field and an electric current [19]. Once the devices' magnetic field is disturbed, the electric current would be disrupted and the sensors would generate a reading to be processed by an Arduino and subsequently pictured on a display screen for rowing athletes. Given the ability of Hall-effect chips and sensors to measure compressive force, these sensors would hypothetically present accurate, helpful data [20]. The fabrication process would include 3D printing a PDMS silicone and rubber mold, filling the mold with a silicone and magnetic powder mixture that comprises the magnet upon setting, and aligning the constructed magnet via existing permanent magnets [21]. Once formed, the force sensors would be adhered to the ergometer's footplates – one on each corner of each footplate – and likewise connected to the processing Arduino through wires or a similar creation, as shown in Figure 7.

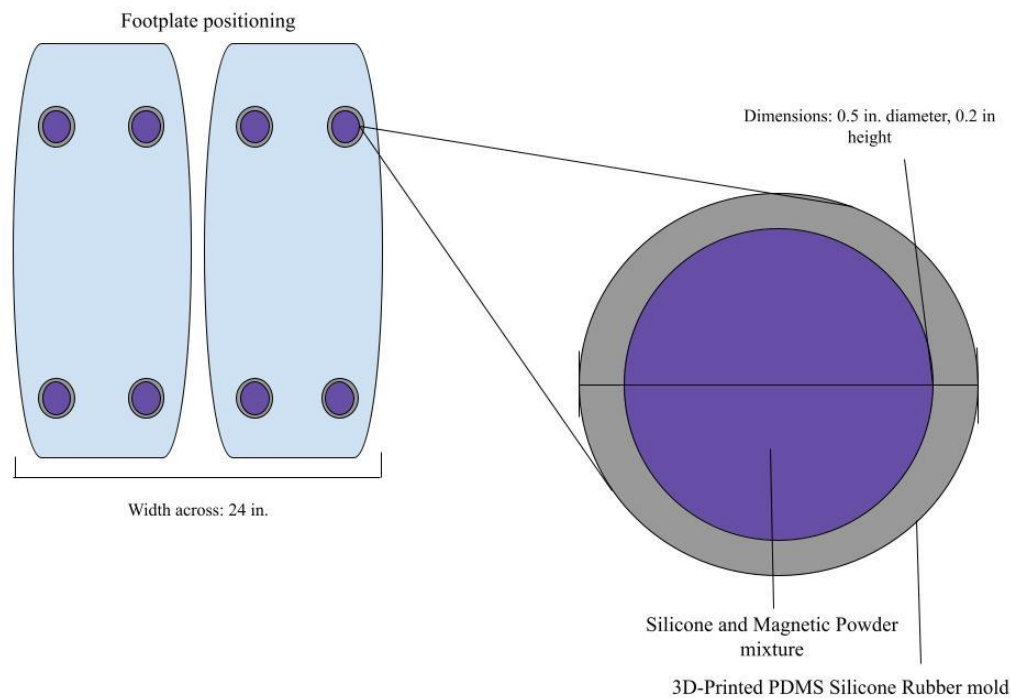

Figure 7. A schematic of the Silicone-Magnetic Force Sensor design.

## Miniature Compression Load Cells

The third design is made up of miniature compression load cells, with one located on the heel of each foot pad. Load cells convert an input mechanical force such as weight or compression into an output, such as a resistance value. As the force applied to the force sensor increases, the electrical signal changes proportionally [22]. Individual load cells were chosen over a force plate as they are more cost efficient. The compression cells have a measuring capacity of 5000N and a sensitivity of  $2.0 \pm 10\% \text{mV/V}$  [23]. Each miniature load cell will be placed on a rectangular thin pad 3D printed out of PLA. The pads will then be screwed beneath the rowers foot pad in order to measure the rowers' load distribution in an uninhibited manner. The load cells will be wired to an Arduino that is connected to a digital panel meter or display monitor system.

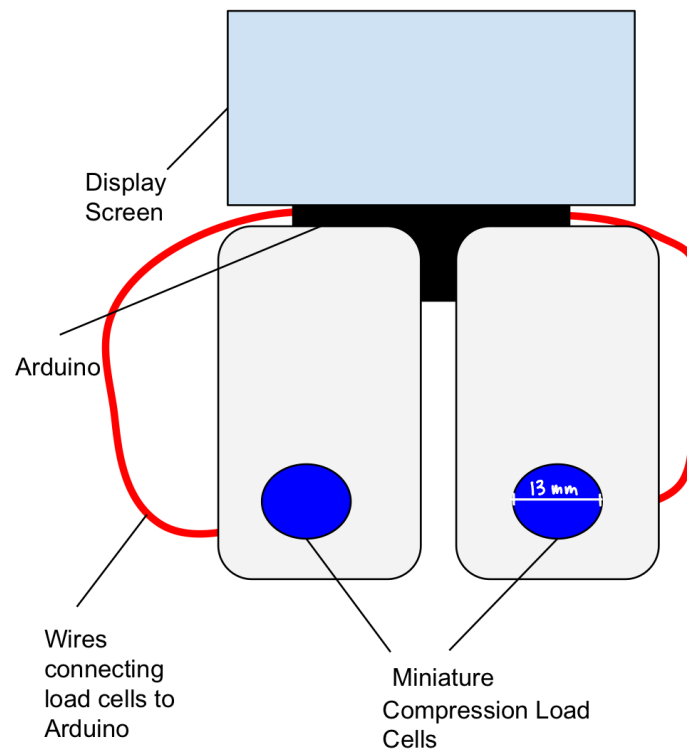



Figure 8: A schematic of the Miniature Compression Load Cell Design.

## IV. Preliminary Design Evaluation

### Design Matrix

#### Force Sensor Location Decision Matrix:

**Table 1:** Design matrix used to rank the three location design ideas. Each category is rated by importance and is used to determine an overall score for each location.

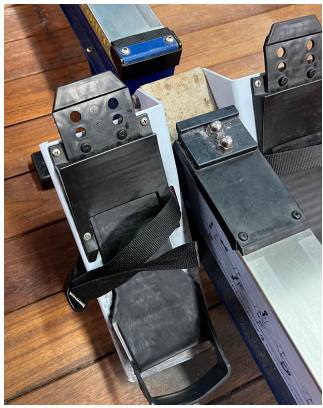
		<b>Ergometer</b>		<b>Boat</b>		<b>Tank</b>	
							
<b>Criteria</b>	<b>Weight</b>	Score (5 max)	Weighted Score	Score (5 max)	Weighted Score	Score (5 max)	Weighted Score
Safety	15	5	15	4	12	4	12
Compatibility	25	1	5	3	15	4	20
Resemblance	30	0	0	5	30	5	30
Complexity	20	3	12	2	8	4	16
Cost	10	3	6	3	6	3	6
<b>Sum</b>	<b>100</b>	<b>Sum</b>	<b>38</b>	<b>Sum</b>	<b>71</b>	<b>Sum</b>	<b>84</b>

### Force Sensor Design Matrix:

**Table 2:** Design matrix used to rank the preliminary force sensor design ideas. Each category is rated by importance and is used to determine an overall score for each design.

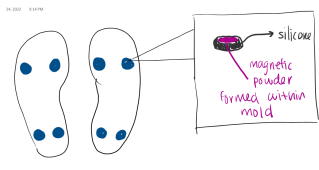
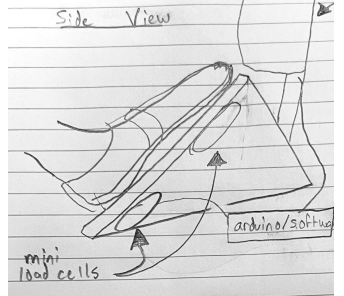
		Force-Sensitive Resistor		Silicone-Magnetic Force Sensor		Miniature Compression Load Cells	
							
Criteria	Weight	Score (5 max)	Weighted Score	Score (5 max)	Weighted Score	Score (5 max)	Weighted Score
Cost	15	5	15	3	9	2	6
Safety	15	3	9	3	9	4	12
Ease of Use	20	4	16	4	16	5	20
Compatibility	15	5	15	4	12	4	12
Functionality	25	4	20	4	20	5	25
Reproducibility	10	4	8	3	6	3	6
<b>Sum</b>	<b>100</b>	<b>Sum</b>	<b>83</b>	<b>Sum</b>	<b>72</b>	<b>Sum</b>	<b>81</b>

## Design Evaluations

### Location Matrix Category Descriptions and Evaluations:

The design matrix to determine the best location to install our device includes the following criteria: safety, compatibility, resemblance, complexity, and cost. Safety is to measure the degree of risk to the user in each location. Compatibility is to determine which location will best fit the device and how transferable to other locations the device can be based on the original location. Resemblance is to consider how similar the location will be to actual rowing. The next criterion, Complexity, is to decide how many outside considerations, based on environment and

use, we will have to take when implementing our design. Cost is a criterion to ensure that we are taking into account the budget constraints before moving forward with a design and location.

### **Location Score Distributions:**

The ergometer came in last place between the three locations, with a total of 32. A score of 5/5 for safety was given because the ergometer should be in dry conditions, and therefore electronics or cords near water is not a concern. It is also the simplest location, with a very straightforward rowing mechanism that the device should not interfere with. The ergometer scored a 1/5 for compatibility because the design would have to modify the ergometer greatly in order to represent real rowing. A score of 0/5 for resemblance was given for the ergometer because it poorly represents the true asymmetrical rowing motion. Athletes are able to be much more symmetrical on the ergometer because they pull straight back, with near even force distribution. However, this poorly represents the full rowing motion in water. In terms of complexity, this location was given a 3/5. Due to fewer environmental factors since the ergometer is indoors, a somewhat higher score for complexity is given. Waterproofing or being able to adapt to climates is not a consideration for the ergometer, giving it a better score. The cost for all three locations should remain similar, as they will all use a similar mechanism. A 3/5 was given for cost, as the design overall is somewhat expensive, but should not vary greatly from design to design.

The boat overall came in second place of the three locations, scoring a total of 71. Firstly, the boat was given a 4/5 in Safety. The design should hardly impact the crew in the boat, but will involve circuitry on open water. Next, the Boat received a 3/5 in Compatibility, as the design will be able to fit comfortably under the footplate in the boat, but will need to be waterproofed. This location scored a 5/5 in Resemblance, as the client's ultimate goal is to have the final design compatible for the boats. For Complexity, the boat scored the lowest again due to waterproofing, and the need for data to be collected portably. For the last category, Cost, the boat scored a 3 with thoughts that waterproofing the design may contribute to additional expenses.

The tank location received a total score of 84. The tank is located in the UW Boathouse, made up of lined up ergometer machines that sit next to a stationary tank of water with controllable current. The tank was given a 4/5 in Safety, as it is a controlled indoor machine. The location also received a 4/5 for Compatibility, as the tank is more similar to an actual boat than



the ergometer; however, the footplates for the tank are more similar to the ergometer than in the shells. The tank scored complete marks in Resemblance, as it allows for sweeping and can emulate similar conditions to rowing on the water. The tank location was given the highest score for Complexity with a 4/5, as it does not require our force sensor to be waterproof. The Tank was also designed by UW Engineers, so we would be able to find their resources if needed for designs. Finally, the Cost of the tank received the same score as the others with a 3/5, as the materials needed to build our design would be very similar across all locations. With these scores, the tank location overall scored the highest of the three.

### **Force Sensor Design Matrix Category Descriptions and Evaluations:**

The design matrix to determine the best design includes the following criteria: cost, safety, ease of use, compatibility, functionality, and reproducibility. Cost is a criterion to ensure that we are taking into account the budget constraints before moving forward with a design. Safety is to determine the degree of risk the device may pose to the user. Ease of Use is to ensure that the rower's technique is not impeded in any way and that any additions to the design are user-friendly. Compatibility is to consider how the device will fit into a location, how transferable it is between locations, and what alterations are necessary to the current setup or the design. Functionality considers the accuracy, reliability, and longevity of the device. Finally, reproducibility outlines how easy the device is to implement for multiple rowers or in a boat.

### **Force Sensor Design Explanations and Score Distributions:**

The force-sensitive resistor design received an overall score of 83/100, making it the highest scored design. It received a 5/5 in the Cost category, because force sensitive resistors can be purchased within budget for roughly \$200 [24], and the team already has access to accompanying circuitry at little to no cost. The design received a score of 3/5 in the Safety category because the resistor and accompanying circuitry will be connected to wall power, which poses a risk to the rower in case they come in contact with any of the elements or the circuit malfunctions. A 4/5 was awarded in the Ease of Use category because the computer display that accompanies the rower will not be mounted directly to the tank ergometer, so the rower and the coach may have difficulty viewing the real-time data. The design received a 5/5 in the Compatibility category because it will not require any modification of the current tank ergometer

system. The design earned a 4/5 in the Functionality category because the sensors will be placed underneath the footplate, which will affect the accuracy of the magnitude of the forces applied. Finally, the design received a 4/5 in the Reproducibility category because the force-sensitive resistor can be easily damaged, so it may have to be replaced often.

The Silicone-Magnetic Force Sensor scored highest in Ease of Use, Compatibility, and Functionality. This device would be planted directly onto the footplates of the tank, erg, or boat; however, due to its projected smaller size, it would not be likely to interfere with the rowers' technique and would fit in and be transferred between all of the considered locations quite easily. Thus, it scored a 4/5 in both Ease of Use and Compatibility. It would also involve use of magnetic sensors and communicating results through a microcontroller to a display, which is a process that would not be overly complex, but may be difficult for rowers and coaches alike to view in real time. As such, this design scored a 4/5 in Functionality. It received middling scores, 3/5, in both Cost and Safety, as the current cost of production and logistics of installation and use are unknown. Finally, considering that this design would involve constructing new magnetic sensors out of magnetic powder and silicone, potentially indicating a long and complicated fabrication process, it received a 3/5 in Reproducibility. This design therefore scored the lowest of the three.

The Miniature Compression Load Cell design received an overall score of 81. The design scored full points in the Functionality and Ease of Use category. Load cells are very reliable and produce results with 5% accuracy and can be used over the long rowing practice times without wearing down [15]. The design can also be integrated easily into the foot plates due to their small size and won't impede on rowing technique. The load cell design received a 2/5 score in the Cost category because load cells can cost upwards of hundreds of dollars and this will be exceeding our budget. Additionally, the load cell design received a 4/5 in Safety due to the fact they will be connected to circuitry which can pose risks if it comes into contact with water, however there are many methods to waterproof components in the circuitry including 3D-printing covers for the load cells. The design received a 4/5 in the Compatibility category because load cells will be embedded effectively within the footplate and won't require any drastic changes in the tank foot plates. Load cells can also directly measure force magnitude and won't require any conversion but they will require a lot more knowledge of coding and software

than the other designs. Lastly, the design received a 3/5 in Reproducibility because of the high cost, reproducing will be difficult within our budget.

## Proposed Final Design

The team decided to move forward with placing the force sensor in the tank, because it most accurately resembles the action of real rowing while remaining both cost-effective and easy to implement. This evaluation is reflected in the location matrix, in which the tank received the highest score. In addition, the rowing team already examines rowers' form in the tank, and placing the device there would accompany this practice well. For the preliminary design, the team chose to continue with the force-sensitive resistor design, because it is within budget and its simplicity will make it easy for the team to prototype and customize for the client. Though the force sensors may not be able to read the magnitude of applied force accurately, the client has emphasized that assessing symmetry is the main concern and the force-sensitive resistor will be able to achieve that goal. Overall, the team has decided to place a force-sensitive resistor circuit in the tank ergometer because it is a simple, cost-effective, and functional way to provide the client with force symmetry measurements that accurately recreate the action of rowing in the rowboat.

## V. Fabrication/Development Process

### Materials

The force-sensitive resistor (FSR) circuit will consist of several key components and materials designed to measure and respond to varying levels of force or pressure. The device consists of four force sensitive resistors consisting of a conductive polymer film that detects pressure through compression. Applied force on the sensing film causes the film to touch the conducting electrodes which changes the film's resistance [25]. The greater the force applied, the lower the resistance value. These force sensitive resistors are inexpensive to use and are easy to implement into a circuit. The FSRs are also water resistant which will prevent any hazards to occur if water gets into the tank. Additionally, the surface where the FSRs will be mounted is already rigid; therefore, an intermediate surface will not be required.

To create the force-detecting circuit, the force sensors will be connected to an Arduino Uno to read the variable resistance of the force sensitive resistors. The Arduino is a microcontroller board and analog to digital converter which will store and execute code we write in Arduino IDE [26]. The Arduino will be used to interpret the signals from the FSR and convert them into force magnitude readings. In order to create the circuit, resistors will be paired with the FSRs. Commonly used resistors values are 10 kilohms, which we will employ in our circuit [27]. A breadboard and jumper wires will be used for testing temporary circuit prototypes and will allow for easy disconnection and connection of components during testing. To convert the resistance change from the FSR into a usable voltage or current signal, signal conditioning circuitry will be employed. This will include components such as resistors and operational amplifiers (op-amps). A USB cable will be used to connect the Arduino to a laptop which will function as the power source and will be used for viewing the real-time force vs time graphs. A 3D printed cover for the Arduino microcontroller will be fabricated from PET-G which is a watertight filament also functioning as a moisture barrier to prevent water infiltration and corrosion of the circuit components [28].

To mount the force sensitive resistors to the footplates of the rowing tank, an adhesive will be used. The adhesive will be easy to detach in case athletes need to adjust placement according to their anatomical foot positions.

## Methods

Once all the circuit components mentioned above are purchased, they will be assembled to create the FSR circuit. The design will then be integrated into the rowing tank foot plate. Proper sensor placement of the FSRs will ensure the FSRs are securely and uniformly placed on the footplate of the rowing tank. The FSR layout will be consistent with the anatomical positions of the athlete's feet during rowing. This accuracy in placement will ensure that the sensors accurately capture the forces generated during each stroke. Additionally, carefully selecting the right double-sided adhesive tape and ensuring all components are properly integrated, will result in a reliable and accurate force-sensitive resistor design will be created for the rowing boat foot plates.

## Final Prototype

The materials listed in Appendix B and the fabrication protocol described above are currently being developed and organized so that a final prototype will be created within the next four weeks. This will allow the team enough time to continue into the testing phase and conclude whether the product has met the specifications described in Appendix A.

## Testing

The purpose of the testing is to ensure that the force sensitive resistor circuits accurately and reliably capture the forces exerted by rowing athletes during steady-state training in rowing tanks. Calibration will occur before any of the testing methods. Calibration will involve measuring and recording the force sensitive resistor output when no force is applied to the footplate. This value will serve as the baseline. Another method of calibration will be to apply a known maximum force to the footplate, and measure and record the force resistor sensitive output at the maximum force level. Overall, our calibration will follow that of the documentation of the purchased FSR.

After calibration, one team member will try the sweep rowing motion in the rowing tank with the mounted circuit design at a given time interval and the rest of the team members will observe the real time force vs time graphs being displayed on a laptop. The team member in the rowing tank will intentionally place all their weight onto one leg while rowing and switch to the other leg to row at an equal time interval. Two other team members will take turns in the rowboat and repeat the same exercises while the rest of the members observe. After the data acquisition from three team members, the team will analyze the force sensitive resistor data to evaluate the members' force distribution during the steady-state training session. The team will assess the force curves for each footplate to identify any irregularities or inconsistencies.

The second phase of testing will involve having athletes from the UW Rowing team test out the design. The athletes will be given a predefined time to row at a steady-state. Steady-state training in rowing refers to a training regimen where athletes row at a consistent and sustainable intensity for an extended period, typically at a moderate pace. The primary goal of steady state is to maintain a steady rhythm and force application throughout the training session. Athletes will need to row at a consistent pace while ensuring the proper force application during both the drive

and recovery phases of the stroke. The athletes will also repeat the same exercise of putting most of their weight on one leg and switching to another leg after a given time. Throughout all the testing, the team will ensure that the baseline and full-force calibration values remain consistent over time. After data collection, the team will analyze the force sensitive resistor data to evaluate the athlete's force distribution during the steady-state training session and when they shift weight onto one leg. A successful FSR design will result in distinct force magnitude readings and significant values between each leg when the team members and athletes exert more force on one leg than the other. During steady state rowing, the FSRs should detect around 900 newtons (within 5% margin) for the peak force of rowing which is the catch to drive position [29].

## VI. Results

There are no testing results available at this time, as the group is still in the process of creating a working prototype.

## VII. Discussion

The proposed final design, the Force-Sensitive Resistor, will be refined, fabricated and tested by the team. Future modifications to the design during development will mainly concern the circuit and display configuration, as the Arduino introduces several constraints. The I/O voltage on the digital pins of the Arduino is 5 V [30]; therefore, the output voltage of the circuit cannot exceed 5 V. Depending on the force-resistance relationship of our chosen FSR, the resistances and configurations of the other circuit components will have to be adjusted such that the analog output voltage read by the Arduino is within this 5 V range. The memory on the Arduino is also a consideration, as the Arduino Uno has 1 KB of EEPROM storage [31]. This introduces a limitation on how much data can be stored for a rower or coach to reference after a training session, thereby constraining the length of a session that can be conducted by the rower or the frequency of data collection during a single stroke. A final constraint of the Arduino is that the maximum reading rate of an analog voltage is 10,000 times a second [31]. This means that the real-time data display is limited to displaying data at this rate, but the actual rate may be lower due to the calculations involved with processing the voltage reading.

Once the circuit is configured, the FSRs will have to be mounted to the ergometer. The team plans to consider multiple mounting methods, including double-sided tape, velcro, and a 3-D printed housing. Because the FSRs have a relatively small sensing area [23], they will have to be moved upon each use to fit the anatomy of each rower. Since each rower has a different foot size, it is not feasible to permanently affix the sensor to the ergometer as rowers with different foot sizes will contact the sensors differently; this will affect the repeatability of force readings. Anatomical landmarks such as the first metatarsal or the center of the calcaneus on each individual rower will be used to align the sensors, so the mounting method will have to be adjustable.

Potential sources of error in data collection and testing stem from this variability in sensor location, and the specifications of the Arduino. If the sensor is not properly aligned with the same anatomical landmark on each rower, the data will not be consistent across tests. In addition, if a sensor is damaged during one test, a subsequent test will have inaccurate data. The Arduino has a 10-bit resolution, making the sensitivity of the Arduino 4.9 mA [31]. This will affect the accuracy of our magnitude measurements, as the Arduino will not be able to sense changes in applied force that produce changes in current less than 4.89 mA. This is not of much concern to the team or client, however, because the main objective is not to measure exact magnitude but relative asymmetry between the lower extremities. Because all of the FSR voltage readings will be at this sensitivity, the relative asymmetry can be measured.

The team has also considered ethical considerations in its design. The design does not infringe on Bylaw 10 in NCAA Division 1 Legislation [32] as it cannot be used to give improper financial aid or banned substances to athletes, and cannot be used in sports wagering. In addition, the device fits well within NCAA regulation on practices or athletically-related activities [33]. The design will also take into account confidentiality of rowers' data in accordance with HIPAA, as rowers can be considered patients of the athletic trainers they work with. HIPAA guarantees that patient data will remain confidential between a patient and their provider [34]. Therefore, rowers' data will be stored on the Arduino only until it can be loaded onto a secure computer. After secure storage, it will be cleared from the EEPROM using the EEPROM Clear function of the Arduino [35].

## VIII. Conclusions

Asymmetrical load distributions contribute to lower extremity injuries for competitive rowers, partially in women. The goal is to design a sensor that can display real-time force data for the UW-Madison Rowing Team as the athletes actively sweep row. The chosen design consists of a force-sensitive resistor that will be mounted with an adhesive underneath the athlete's footplate. As force is applied through the foot, the resistance decreases, increasing the electrical output, which will be analyzed on a laptop. The design will be placed in the indoor rowing tank located at the UW-Madison Porter Boathouse. In the future, the design will be relocated to a racing shell for eight, in order to more accurately resemble outdoor racing conditions. Upon transitioning, the design will have to be waterproofed to prevent circuit shortening, as well as the display. Data may also be collected and uploaded for later analysis as an alternative to waterproofing the display.



## IX. References

- [1] S, Arumugam, et al. “Rowing Injuries in Elite Athletes: A Review of Incidence with Risk Factors and the Role of Biomechanics in Its Management.” *Indian Journal of Orthopaedics*, vol. 54, no. 3, Jan. 2020. [pubmed.ncbi.nlm.nih.gov](https://pubmed.ncbi.nlm.nih.gov), <https://doi.org/10.1007/s43465-020-00044-3>
- [2] Buckeridge, E. M., et al. “Biomechanical Determinants of Elite Rowing Technique and Performance: Rowing Technique and Performance.” *Scandinavian Journal of Medicine & Science in Sports*, vol. 25, no. 2, Apr. 2015, pp. e176–83. DOI.org (Crossref), <https://doi.org/10.1111/sms.12264>.
- [3] “2D\_Stretcher,” Biorow. [https://biorow.com/index.php?route=product/product&path=61\\_115&product\\_id=109](https://biorow.com/index.php?route=product/product&path=61_115&product_id=109) (accessed Sep. 21, 2023).
- [4] I. E. Inc, “Pressure Measurement Sensors and Rugged Touchpads.” Accessed: Oct. 11, 2023. [Online]. Available: <https://www.interlinkelectronics.com/fsr-ux-400>
- [5] A., Buckeridge E;Hislop S;Bull A;McGregor. “Kinematic Asymmetries of the Lower Limbs during Ergometer Rowing.” *Medicine and Science in Sports and Exercise*, U.S. National Library of Medicine, [pubmed.ncbi.nlm.nih.gov/22677926/](https://pubmed.ncbi.nlm.nih.gov/22677926/). Accessed 10 Oct. 2023.
- [6] “Lower Back Pain Relief for Rowers.” Performance Health, [www.performancehealth.com/articles/lower-back-pain-relief-for-rowers](https://www.performancehealth.com/articles/lower-back-pain-relief-for-rowers). Accessed 11 Oct. 2023.
- [7] Cheri, “Using the Force Curve,” Concept2, May 18, 2012. <https://www.concept2.com/indoor-rowers/training/tips-and-general-info/using-the-force-curve> (accessed Sep. 29, 2023).
- [8] “Force Plates,” Bertec. <https://www.bertec.com/products/force-plates> (accessed Sep. 13, 2023).
- [9] S. Arumugam, P. Ayyadurai, S. Perumal, G. Janani, S. Dhillon, and K. A. Thiagarajan, “Rowing Injuries in Elite Athletes: A Review of Incidence with Risk Factors and the Role of Biomechanics in Its Management,” *Indian J Orthop*, vol. 54, no. 3, pp. 246–255, Jan. 2020, doi: 10.1007/s43465-020-00044-3.
- [10] E. Wittich, “Symmetry - bat logic,” [www.batlogic.net](http://www.batlogic.net), <https://batlogic.net/wp-content/uploads/2017/08/Row360-Issue-008-Symmetry-of-Sweep.pdf> (accessed Oct. 12, 2023).

- [11] R. E. Boykin et al., “Labral injuries of the hip in rowers,” *Clinical Orthopaedics & Related Research*, vol. 471, no. 8, pp. 2517–2522, 2013. doi:10.1007/s11999-013-3109-1
- [12] “Jill Thein-Nissenbaum, Physical Therapy (PT) Program,” UW School of Medicine and Public Health. Accessed: Oct. 06, 2023. [Online]. Available: <https://www.med.wisc.edu/education/physical-therapy-program/faculty-and-staff/jill-thein-nissenbaum/>
- [13] “Tricia De Souza | Women’s Rowing Coach,” Wisconsin Badgers. Accessed: Oct. 06, 2023. [Online]. Available: <https://uwbadgers.com/sports/womens-rowing/roster/coaches/tricia-de-souza/1617>
- [14] david, “RowErg,” Concept2. Accessed: Oct. 05, 2023. [Online]. Available: <https://www.concept2.com/indoor-rowers/concept2-rowerg>
- [15] Q. Liu, Y. Dai, M. Li, B. Yao, Y. Xin and J. Zhang, "Real-time processing of force sensor signals based on LSTM-RNN," 2022 IEEE International Conference on Robotics and Biomimetics (ROBIO), Jinghong, China, 2022, pp. 167-171, doi: 10.1109/ROBIO55434.2022.10011703.
- [16] R. Taylor, “How to Become an Olympic Rower: Our Ultimate Guide from an Olympian,” [www.rowingcrazy.com](http://www.rowingcrazy.com), Apr. 27, 2023. <https://www.rowingcrazy.com/how-to-become-an-olympic-rower/> (accessed Sep. 22, 2023).
- [17] “Climate & Weather Averages in Madison, Wisconsin, USA,” [www.timeanddate.com](http://www.timeanddate.com). <https://www.timeanddate.com/weather/usa/madison/climate>
- [18] “In-Depth: Interfacing Force Sensing Resistor (FSR) with Arduino,” Last Minute Engineers, Apr. 06, 2020. <https://lastminuteengineers.com/fsr-arduino-tutorial/> (accessed Sep. 26, 2023).
- [19] “How Hall effect sensors and probes work,” Explain that Stuff, Jul. 29, 2009. <http://www.explainthatstuff.com/hall-effect-sensors.html> (accessed Sep. 23, 2023).
- [20] J. D. Miller, D. Cabarkapa, M. J. Hermes, A. C. Fry, and C. J. Berkland, “Soft Magnetic Composites as Quantitative 3D Compression Sensors for Wearable Technology,” *Advanced Materials Technologies*, vol. 7, no. 3, p. 2100784, 2022, doi: 10.1002/admt.202100784

- [21] J. D. Miller et al., “Novel 3D Force Sensors for a Cost-Effective 3D Force Plate for Biomechanical Analysis,” *Sensors (Basel)*, vol. 23, no. 9, p. 4437, May 2023, doi: 10.3390/s23094437.
- [22] “Load cell amplifier circuit | how it works | futek,” FUTEK, <https://www.futek.com/load-cell-circuit> (accessed Oct. 12, 2023).
- [23] A. D. SAVAGE, “ATO Compression Load Cell 100kg, Button Type, Weighing Mini Load Cell Sensor 100kg Strain Gauge Scale Sensor Miniature Compression Force Sensor,” Amazon, [https://www.amazon.com/dp/B0BX1Z3VSB/ref=emc\\_b\\_5\\_i?th=1](https://www.amazon.com/dp/B0BX1Z3VSB/ref=emc_b_5_i?th=1) (accessed Oct. 11, 2023).
- [24] “Force Sensors (FlexiForce) | Tekscan.” <https://www.tekscan.com/store-category/force-sensors-flexiforce-0> (accessed Sep. 27, 2023).
- [25] Ada, Lady. “Force Sensitive Resistor (FSR).” Adafruit Learning System, [learn.adafruit.com/force-sensitive-resistor-fsr/overview](https://learn.adafruit.com/force-sensitive-resistor-fsr/overview). Accessed 29 Sept. 2023.
- [26] R. Kulkarni, “ARDUINO!!! — — — Load,” Medium, Aug. 18, 2023. <https://medium.com/@iamRadhaKulkarni/arduino-load-9f35dbe4bc1e> (accessed Sep. 22, 2023).
- [27] R. C. Kirt Blattenberger, “Standard resistor values,” RF Cafe, <https://www.rfcafe.com/references/electrical/resistor-values.htm> (accessed Oct. 11, 2023).
- [28] Alexandra, “Waterproofing 3D prints: 5 easy solutions,” BCN3D Technologies, <https://www.bcn3d.com/waterproofing-3d-prints-5-solutions-to-creating-water-resistant-models/#:~:text=and%20aerospace%20industry,-,PET%2DG,very%20easy%20material%20to%20print.> (accessed Oct. 11, 2023).
- [29] N. Découfour, F. Barbier, P. Pudlo, and P. Gorce, “Forces Applied on Rowing Ergometer Concept2®: a Kinetic Approach for Development (P94),” *The Engineering of Sport 7*, vol. 1, pp. 483–490, 2008, Accessed: Sep. 29, 2023. [Online]. Available: [http://bionics.seas.ucla.edu/education/Rowing/Biomechanics\\_2008\\_01.pdf](http://bionics.seas.ucla.edu/education/Rowing/Biomechanics_2008_01.pdf)
- [30] “UNO R3 | Arduino Documentation.” Accessed: Oct. 11, 2023. [Online]. Available: <https://docs.arduino.cc/hardware/uno-rev3>
- [31] “analogRead() - Arduino Reference.” Accessed: Oct. 11, 2023. [Online]. Available:

<https://www.arduino.cc/reference/en/language/functions/analog-io/analogread/>

[32]“Legislative Services Database - LSDBi.” Accessed: Oct. 11, 2023. [Online]. Available: <https://web3.ncaa.org/lstdbi/search/bylawView?id=11561>

[33]“Legislative Services Database - LSDBi.” Accessed: Oct. 11, 2023. [Online]. Available: <https://web3.ncaa.org/lstdbi/search/bylawView?id=9024>

[34] “Health Insurance Portability and Accountability Act of 1996,” ASPE. <https://aspe.hhs.gov/reports/health-insurance-portability-accountability-act-1996> (accessed Sep. 21, 2023).

[35] “A guide to EEPROM | Arduino Documentation.” Accessed: Oct. 11, 2023. [Online]. Available: <https://docs.arduino.cc/learn/programming/eprom-guide>

## X. Appendix

### Appendix A: Product Design Specifications



## PRODUCT DESIGN SPECIFICATIONS: FORCE PLATES FOR ROWING BIOMECHANICS

---

*BME 300/200, Section 303*

**Clients: Dr. Jill Thein-Nissenbaum and Ms. Tricia De Souza**

**Advisor: Dr. Joshua Brockman**

Team Members:

Team Leader: Neha Kulkarni

Communicator: Simerjot Kaur

BSAC: Emily Wadzinski

BWIG: Bryan Topercer and Orla Ryan

BPAG: Simret Bhatia

**Function:**

Force sensors have been widely used in sports biomechanics to measure load distribution and center of pressure for the purpose of correcting form and mitigating injuries. However, getting real time data during the sport is often difficult to obtain in non clinical settings and may be very expensive to implement. Rowing is a rigorous sport that can lead to numerous lower extremity injuries due to asymmetries in load distribution when not following proper technique. Additionally, this asymmetry is impossible to quantify visually and current methods include using stationary rowing simulation machines that disparately underestimate the mechanical power required against water currents [1]. Specifically, these current methods of evaluating rowing form focus mainly on upper body extremities such as stroke power and involve studies outside of the rowing environment. Our design aims to provide accurate real time data of lower extremities by integrating a force sensor system in the rowboat to transduce force loading measurements that rowers can view while on the water. The application of our design will allow athletes and coaches to limit injury through avoiding asymmetric force transmission.

**Client Requirements:**

- The design must be compatible and inclusive with all weight classifications of rowboats (50kg to 90kg +) and foot sizes [2].
- The device must be strong enough to withstand the force exerted by rowers during the drive phase of the stroke [3].
- The device must accurately measure the load in each leg and translate the data to an interface that provides real-time data viewing while rowing.
- The device must be able to operate in wet conditions and humid environments.
- The client desires an easily integrated force measuring system that should operate without requiring change in rowing technique.
- The device should be fairly lightweight so as to not affect the weight of the rowboat.

**Design Requirements:****1. Physical and Operational Characteristics:***a. Performance Requirements:*

- The product must track the degree to which rowers are exerting symmetric force through their entire lower extremity, to track any asymmetry present.
- The product should provide real time data during a rower's row time so they can monitor any fluctuations as they occur.
- The product should be able to store data and display it through a visual interface so coaches and rowers can see the data in real time and analyze it later.
- The product should be able to display a force vs time graph at the end of a row as well as show the force during the catch to drive phase.
- The product should be waterproof.

*b. Safety:*

- This product should not disrupt the motion of the rower or the ergometer as a stroke is completed.
- This product should not cause any electrical shocks to the rower's and have minimal large cords in close proximity to the rower. The device needs to be plugged into an outlet with standard voltage of 120 V [4].
- This product should be able to be cleaned between uses with alcohol-based solution or soap and water. Bleach and/or hydrogen peroxide should be avoided [5].
- This product should not have any sharp edges.

*c. Accuracy and Reliability:*

- The device should be easy to replace if any of the components fail.
- The product should give data with high accuracy with a margin of error at 5% [6].

*d. Life in Service:*

- A typical rowing career for an Olympic rower tends to end near a rower's late 20s or early 30s. From college to this time, the device would have to be in service for about 10-12 years [7].

*e. Shelf Life:*

- The product will have a shelf life of around 50,000 hours to be able to be used for multiple college careers. This will allow for an array of results and different data to see its full effectiveness.
- The design should not necessarily have any features that wear away with time.

*f. Operating Environment:*

- The client would like to have the device at least inside on an ergometer. This would consist of room temperature conditions. These conditions are around 20-22° C and low humidity
- The client would like the force plates to be inside of their boats, which travel through the water. This would be a wet environment, could be cold or hot in temperature, and can withstand natural conditions such as rain. The plates would have to be waterproof and functional in fluctuating temperatures. The outdoor rowing season takes place from April to around October, where it becomes too cold to row outside. The average conditions in Madison during this time are the following [8]:
  - Temperature Range: 8.3° C to 22.2° C
  - Humidity: 62% - 73%
  - Rain Levels: 2.9 cm - 5.44 cm

*g. Ergonomics:*

- The design will easily allow users to view real time data and get feedback while they are rowing.
- The plates will not add any unnatural feeling for the rowers, and therefore they will not have to change their technique in order to use them.

*h. Size:*

- The client has expressed a main interest in placing such a device in practice ergometers as well as practice rowing tanks.
- After determining the brand of ergs used by the client both for conditioning and in tanks to be Concept2, it is noted that the width of the machine is 60.96 cm [9] so the device should fit within those constraints.

*i. Weight:*

- On their own, the Concept2 RowErg® weighs between 25.9 and 30.8 kg [8]. The device should be able to withstand this weight.
- The device will need to be lightweight enough so that users have no trouble rowing with the same technique and efficiency.

*k. Materials:*

- Current force sensors are typically constructed of silicone rubber elastomer with magnetic powders or particles used in calculations [10].



- Additionally, they are often cased in pure silicone or a similar material to maintain their shape, then adhered to thin aluminum plates as is “standard in force plate fabrication” [10].
  - The team will try to hold to these industry standards, using these materials as guidelines.
- Finally, the client has mentioned that some level of waterproofing will be a necessity for the product, given the likelihood of water exposure or possible immersion. Past experiments with sensors indicate that a possible method is laser direct writing, in which a barrier is created using a 405 nm laser [11].

#### *1. Aesthetics, Appearance, and Finish:*

- At this moment, without an idea of specific materials that will be purchased, measurements for target placement of the device, and other necessary parameters, it is difficult to say exactly what the desired finish will be. Given that current practice ergometers used by the client are finished using a powder coat, and the devices’ legs are made of both aluminum and steel, these materials can be kept in mind when considering aesthetics [9].
- Overall, the team aims to produce a product that seamlessly fits into a rowing boat or ergometer, prioritizes comfortable foot placement for rowers, and does not interrupt users’ technique with any added bulkiness.

## **2. Product Characteristics:**

#### *a. Quantity:*

- The client would like there to be at least 8 force sensor systems, in order to have one per person in a shell for 8 sweep rowers [12]. The sensors should be easily transferable between the shells and the rowing tanks, which hold a capacity of 24 rowers (12 per tank) [13]. With increased supplies and funding, the quantity of sensors may be considerably increased to eventually have one sensor for every rower, in which the University of Wisconsin’s crew team currently has around 205 athletes.

#### *b. Target Product Cost:*

- The budget for this design project is between \$100-\$500 . The budget may be increased with approval from the UW Athletic Department.
- The competing designs listed in part 3d of the PDS have costs significantly greater than our budget. BioRow’s 2D Flat stretcher force plate costs over \$2000. Small-sized multi axis load cells

can range from \$300-\$500 [14]. In order to make a product within our target, load cells are more cost efficient.

### 3. Miscellaneous:

#### *a. Standards and Specifications :*

- The device must not interfere with the construction of the Concept2 RowErg® such that it fails to comply with the ASTM Standard Specifications for Fitness Equipment (ASTM F2276 – 23) [15].
  - Specifies that edges should be free of burrs and sharp edges, and corners should be chamfered
  - Specifies that the ergometer should withstand 1560 on/off cycles
  - Specifies that the footplate should be slippage-resistant
  - Specifies that the ergometer should be able to withstand 136 kg or the maximum user weight, whichever is greater
- The device must also comply with the ASTM Standard Specification for Universal Design of Fitness Equipment for Inclusive Use by Persons with Functional Limitations and Impairments (ASTM 3021-17), such that rowers with functional limitations and impairments can use the device [16].
  - Specifies that color contrast on any visual display must be greater than or equal to 70%
  - Specifies that font size should be at least 10 mm
  - Specifies that the display should continue to display visual feedback at least 5 seconds after exercise has stopped.

#### *b. Customer:*

- The target customer for our product is the Physical Therapist and Athletic Training Staff for the University of Wisconsin Rowing Team.
- Because the product will be used by physical therapists and athletic trainers as they work with athletes, visualizing the magnitude of force asymmetry is extremely important for athlete understanding and adaptation; hence, the device should have an easily interpretable interface that is updated with real-time data from the athlete as they perform rowing strokes.
- The device should also be compatible with the Concept2 RowErg®, which is the ergometer used by the University of Wisconsin Rowing Team.

- The footrests should remain adjustable, and the wheels and upright storage capabilities should be unimpeded [8].

*c. Patient-Related Concerns:*

- The device should not interfere with proper rowing technique or injure the athlete in any way.
- The device should not interfere with the ergometer or boat such that they begin to degrade or malfunction.
- The device should be accompanied by a data storage drive or other technology that allows for patient performance data to be stored confidentially, in compliance with HIPAA [17].

*d. Competition:*

- Bertec® produces portable force plates for gait, balance, and performance analysis [18].
  - The load cells contained inside utilize strain gauges and transducers to measure forces and moments in the x, y, and z directions
  - The portable force plates have a sampling frequency of 1000 Hz.
  - The portable force plates have loading capacities of 4440, 8880, or 17760 N.
- Biorow produces a 2D force sensor that uses four load cells fixed to a plate, and the plate is screwed between the foot straps of the ergometer and the foot stretchers [19].
  - The load cells can measure from -800 to +3200 N.

## References:

- [1] G. Treff, L. Mentz, B. Mayer, K. Winkert, T. Engleder, and J. M. Steinacker, "Initial Evaluation of the Concept-2 Rowing Ergometer's Accuracy Using a Motorized Test Rig," *Frontiers in Sports and Active Living*, vol. 3, Jan. 2022, doi: <https://doi.org/10.3389/fspor.2021.801617>.
- [2] "Sizes - Wintech Racing," *wintechracing.com*. <https://www.wintechracing.com/technology/sizes/> (accessed Sep. 22, 2023).
- [3] S. Arumugam, P. Ayyadurai, S. Perumal, G. Janani, S. Dhillon, and K. A. Thiagarajan, "Rowing Injuries in Elite Athletes: A Review of Incidence with Risk Factors and the Role of Biomechanics in Its Management," *Indian J Orthop*, vol. 54, no. 3, pp. 246–255, Jan. 2020, doi: 10.1007/s43465-020-00044-3.
- [4] "Site Home - Global Site," *Stanford.edu*, 2017. <https://simtk-confluence.stanford.edu:8443/> (accessed Sep. 22, 2023).
- [5] "How should I clean or disinfect the Force Plate?," *success.spartascience.com*. <https://success.spartascience.com/en/knowledge/how-should-i-clean-or-disinfect-the-force-plate> (accessed Sep. 22, 2023).
- [6] Q. Liu, Y. Dai, M. Li, B. Yao, Y. Xin and J. Zhang, "Real-time processing of force sensor signals based on LSTM-RNN," *2022 IEEE International Conference on Robotics and Biomimetics (ROBIO)*, Jinghong, China, 2022, pp. 167-171, doi: 10.1109/ROBIO55434.2022.10011703.
- [7] R. Taylor, "How to Become an Olympic Rower: Our Ultimate Guide from an Olympian," *www.rowingcrazy.com*, Apr. 27, 2023. <https://www.rowingcrazy.com/how-to-become-an-olympic-rower/> (accessed Sep. 22, 2023).
- [8] "Climate & Weather Averages in Madison, Wisconsin, USA," *www.timeanddate.com*. <https://www.timeanddate.com/weather/usa/madison/climate>
- [9] David, "RowErg," *Concept2*, May 09, 2012. <https://www.concept2.com/indoor-rowers/concept2-rowerg>
- [10] J. D. Miller et al., "Novel 3D Force Sensors for a Cost-Effective 3D Force Plate for Biomechanical Analysis," *Sensors (Basel)*, vol. 23, no. 9, p. 4437, May 2023, doi: 10.3390/s23094437.
- [11] W. Zhou, Y. Yu, S. Bai, and A. Hu, "Laser direct writing of waterproof sensors inside flexible substrates for wearable electronics," *Optics & Laser Technology*, vol. 135, p. 106694, Mar. 2021, doi: 10.1016/j.optlastec.2020.106694.
- [12] "Rowing Glossary," *Dallas United Crew*. [https://www.dallasunitedcrew.org/rowingglossary#:~:text=Octuple%20\(8x\)%3A%20A%20shell](https://www.dallasunitedcrew.org/rowingglossary#:~:text=Octuple%20(8x)%3A%20A%20shell) (accessed Sep. 22, 2023).
- [13] "Facilities - Porter Boathouse," *Wisconsin Badgers*. [https://uwbadgers.com/sports/2015/8/21/GEN\\_2014010131.aspx](https://uwbadgers.com/sports/2015/8/21/GEN_2014010131.aspx)
- [14] "3 axis load cell, 3 axis load cell Suppliers and Manufacturers at Alibaba.com," *www.alibaba.com*. <https://www.alibaba.com/showroom/3-axis-load-cell.html> (accessed Sep. 22, 2023).

[15] “Standard Specification for Fitness Equipment” <https://www.astm.org/f2276-23.html> (accessed Sep. 20, 2023).

[16] “Standard Specification for Universal Design of Fitness Equipment for Inclusive Use by Persons with Functional Limitations and Impairments” <https://www.astm.org/f3021-17.html> (accessed Sep. 20, 2023).

[17] “Health Insurance Portability and Accountability Act of 1996,” ASPE. <https://aspe.hhs.gov/reports/health-insurance-portability-accountability-act-1996> (accessed Sep. 21, 2023).

[18] “Force Plates,” Bertec. <https://www.bertec.com/products/force-plates> (accessed Sep. 13, 2023).

[19] “2D\_Stretcher,” Biorow. [https://biorow.com/index.php?route=product/product&path=61\\_115&product\\_id=109](https://biorow.com/index.php?route=product/product&path=61_115&product_id=109) (accessed Sep. 21, 2023).

## Appendix B: Materials and Expenses

Item	Description	Manufacturer	Mft Pt#	Vendor	Vendor Cat#	Date	QTY	Cost Each	Total	
Wire terminal	Connector for al	Multicomp pro	MC29391	Newark	34P2159	10/11/2023		\$5.00	\$0.08	\$0.40
Fuse	1 A, 125 V, 5mm	Littlefuse	26K7739	Newark	26K7739	10/11/2023	1	\$0.89		\$0.89
Wire - Black	16 AWG hook-up	Multicomp pro	24-15050	Newark	44AC9035	10/11/2023	0.005	\$17.09		\$0.09
Wire - White	16 AWG hook-up	Alphawire	461626 WH005	Newark	98B9507	10/11/2023	0.005	\$38.32		\$0.19
Wire - Green	20 AWG solid wi	Alphawire	422001 GR005	Newark	28Y5639	10/11/2023	0.005	\$24.48		\$0.12
Wire - Blue	22 AWG solid ho	Multicomp pro	24-15416	Newark	68X4805	10/11/2023	0.04	\$2.49		\$0.10
Wire terminal	Connector for 2;	AMP-TE Connect	61048-1	Newark	07AH7925	10/11/2023	2	\$0.36		\$0.72
Arduino Uno Rev	Microcontroller/	ARDUINO	A000066	Arduino	76300492	10/11/2023	1	\$24.00		\$24
Force Sensitive F	Sensing area tha	Sparkfun	no part number	Sparkfun	no part number	10/11/2023	4	\$7.50		\$30