

Engineering World Health Design: Temperature Tester

April 28 , 2006

Team Members:

Sasha Cai Lesher-Pérez (Team Leader)
Sarah Offut (Communications)
Carly Brown (BSAC)
Ryan Thome (BWIG)

Client

John Webster, Ph.D.
Department of Biomedical Engineering
College of Engineering
University of Wisconsin-Madison

Advisor

Professor Paul Thompson
Department of Biomedical Engineering

Table of Contents

Abstract.....	3
Problem Statement.....	3
Background.....	3
Design Constraints.....	5
Alternative Casing Design 1: Disposable.....	5
Alternative Design 2: Replaceable Battery	6
Proposed Design: Probe	7
Final Design.....	9
<i>The Circuit</i>	9
<i>Casing</i>	12
Testing.....	13
Conclusion.....	14
References	15
Appendix A	17
Appendix B.....	18

Abstract

Our project, from Engineering World Health, was to design a device for testing the temperature in an incubator or water bath. The temperature tester must signify a deviation of temperature of ± 0.5 ° C from 37 ° C. The greatest restriction placed on our design was the cost of the device, \$3.00 per unit. The final design is based on a circuit that used a Wheatstone bridge with a thermistor, a potentiometer and a dual comparator that is connected to two LEDs to alert the user of temperature deviations. The circuit is incased in PVC piping and epoxy, and features a removable battery. Future work on the project includes increasing battery life and decreasing size.

Problem Statement

The goal for our project this semester is to develop a device which indicates whether a water bath or incubator is at 37 ° C; if the temperature deviates by more than 0.5 ° C, there will be a visual alarm to indicate the change. The design was inspired by an Engineering World Health project. The project is to design a temperature tester that could measure the previously mentioned temperatures within hospitals and laboratories in third world communities. This is to all be done staying under a budget of \$3.00.

Background

Engineering World Health (EWH) is a charitable organization that has been created in an effort to adequately answer the problems in disadvantaged communities around the world by providing and maintaining appropriate, inexpensive medical technologies within these communities. EWH harnesses the resources of collegiate engineering programs to improve healthcare around the world.

A way that EWH improves the equipment in hospitals and laboratories is through design projects. Projects are open to anyone who would like to design and create prototypes for the specific problem statements. Design projects are problem statements with project specifications that serve as moderate guidelines to reach an economically viable solution for

these hospitals. The problem statement our group has chosen to address is: determination of water temperature for water baths used in hospitals, as a form of incubation, that do not have any mechanism for alerting the hospital staff of deviation from the desired temperature. The motivation of the project is to create an accurate method and device that will allow the staff to more efficiently and effectively regulate water temperatures within the bath.

EWH noted that the project was designed to be used in water baths and incubators in hospitals and laboratories. Water baths and incubators are used in hospitals when a stable environment is essential. A few situations where this is needed in hospitals is heating beakers, incubating premature babies, or growing biological cultures.

Current products on the market include the

Ice-Box Thermometer, seen in Figure 1, the

Traceable Alarm Thermometer and the Alarm

Thermometer Monitor. These devices are similar in

that they both can be preset to a specific range of

temperatures in which the temperature is desired. If the thermometer detects a temperature out of this range, an audible alarm is set off. All have LED screens to read the current

temperature reading. However, the prices on these

products, \$19.00, \$30.76, and \$22.00 respectively are

above our design specifications. The accuracy on the

Traceable Alarm Thermometer, seen in Figure 2, and the

Alarm Thermometer Monitor are $\pm 2^\circ\text{C}$ and $\pm 1^\circ\text{C}$

respectively. Our design specifications call for an accuracy

of 0.1°C . The Traceable Alarm Thermometer can only be



Fig 1. Ice-box Thermometer (Thermoworks, 2004)



Fig 2. Traceable Alarm (Control Company, 2006)

preset to 1° C increments. The desired design needs to detect the 0.5 ° C change in the water; these designs do not meet the need in cost and accuracy.

Design Constraints

Our project specifications from EWH were somewhat simplistic, so we decided to expand the specifications to create a more reliable and adequate device for hospital environments. The design should be no larger than one inch by one inch by four inches (1” x 1” x 4”). It should be water resistant and heat resistant up to 45 ° C. Our design should be able to detect 0.1 ° C change within the water temperature, but will register 0.5 ° C deviation from the desired temperature of 37 ° C. Our device, not including batteries, will have a shelf life of five years and an operational life of two years. The source of power will be a nine volt battery. Our optimum weight will be less than 230 grams or half a pound and the prototype shall be portable and easy to carry. The price of one unit, if mass produced, will not exceed \$3.00. Price is a large constriction for all projects proposed by EWH. The communities and hospitals that will be purchasing and receiving these products have inadequate funds and lack of economic resources. Complete PDS can be seen in Appendix A.

Alternative Casing Design 1: Disposable

The first alternative, Figure 3, to encase this design is a disposable design. This design is by far the easiest to manufacture, since it is disposable. The circuit and a battery are sealed in a plastic case. To date, no material has been decided upon. The LEDs will be embedded into the casing with a seal around their edge so that water is not allowed to leak

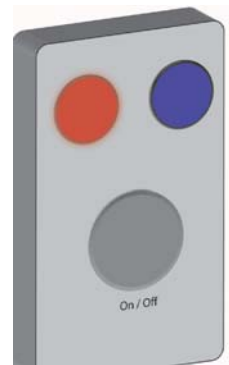

Fig 3. Disposable Design

in; same will go for the button switch. The disposable design can be seen in Figure 2. The way this is designed, it will have the ability to be water submersible. The whole unit would be 1"x1"x 4", as desired by EWH.

The advantages of this design are it will be easy to use and easier to manufacture than our other designs. The disadvantages of this design all deal with the fact that it is disposable. This makes it less cost effective, instead of replacing the battery; the user has to purchase a new unit. This shorter life span is not ideal for use in a third world country. It will also be difficult to insure that the whole unit is water tight, which could also cause difficulties for the user.

Alternative Design 2: Replaceable Battery

The Replaceable Battery design, Figure 4, is similar to the Disposable design except that it has an accessible compartment to allow for the removal and replacement of a battery. One of the most important requirements of our design is that it must be able to be manufactured and maintained at very little cost to the end user. This design, by implementing

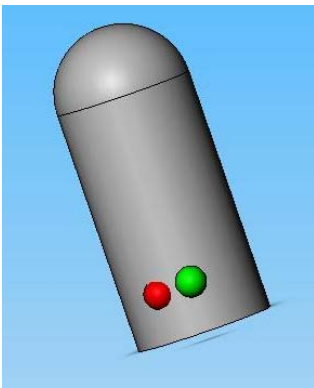

Fig 4. Replaceable Battery Design

a replaceable battery, raises the initial cost of the device slightly, but is much more cost-effective in the long run.

The addition of a replaceable battery, a seemingly slight deviation in methodology, has a relatively large effect on the design of the device, as we must incorporate a compartment that can be easily accessed but also maintains a water-tight seal. The solution we have come up with is similar to the design of several submersible pH testers currently on the market. The device is a long, hollow, cylindrical tube that will encase the circuit in one compartment and the battery in another. The circuit will be

in one compartment that is completely sealed off from the rest of the device, and will be inaccessible to the user. The voltage terminals from the circuit will penetrate the upper wall, and poke into the battery compartment. This will allow the battery to be fitted on top of the protruding terminals and provide power to the circuit. The top of the battery compartment will be a threaded cap that screws on top of the device, and with the help of a rubber washer, creates a water-tight seal.

One of the key advantages of this design is that, as previously mentioned, it is more cost-effective than the disposable design. If the disposable device costs \$2.50 per unit, the reusable device \$3.00 per unit, and then an extra \$3.00 for a 9 V battery, it is much cheaper in the long run to be able to just replace the battery, as opposed to the whole unit as well. Another advantage of this design is that is very easy to use, and also easy to maintain.

The main disadvantage to this design is that, because it is meant to rest on the bottom of the incubator to be able to achieve an accurate temperature reading, it is hard to see the visual alarm. Depending of the depth of the water bath, and the direction the device is facing, it could be almost completely obscured from the operator's view. One minor disadvantage is that the device is slightly more complicated in design, and because of the necessary extra parts to support the removable battery, it would be harder to manufacture.

Proposed Design: Probe

The key disadvantages of the two prior designs are that they rest on the bottom of the incubator, and therefore are harder to see when the visual alarm is activated. To counteract this problem, we needed to devise a way to have the alarm stay above water level, but still have the thermistor be able to measure the change in water temperature. We decided the most practical solution to this problem was to implement a probe into the device. This design

feature allows the thermistor to be submersed in the water, encased in a water-tight covering, while measuring the change in temperature and allowing the LED visual alarm to remain above the water.

The case design in this device is identical to the case proposed in the Replaceable Battery design, only it implements a probe at the bottom. The probe, seen in Figure 5, a flexible, water-proof covering, protrudes from the base of the

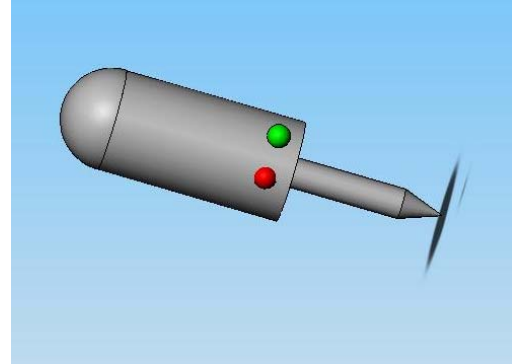

Fig 5. Probe

circuit compartment. It is essentially just an extension of this compartment, allowing the thermistor to be closely surrounded by the external environment without exposing the rest of the circuit to these potentially hazardous conditions. The circuit design will remain exactly the same, only the thermistor will not be soldered to the circuit board. Extra lengths of copper wire will allow the thermistor to be placed in the probe, while still being electronically connected to the circuit board.

The key advantage of this design is that it allows the visual alarm to be easily seen because it is placed above the water. This is extremely important, as it is not helpful to the operator if the devices functions properly, but the alarm does not get their attention. This design also benefits from having a replaceable battery, which increases its overall lifespan and makes it more cost-effective.

The major disadvantage of this design is that it is longer than the other two designs, which makes it slightly less portable. However the probe is flexible, which offsets this extra length slightly. The Probe design also suffers from a few of the same disadvantages as the

Replaceable Battery design. It is a more complicated design, and because of extra components, it will be harder to manufacture.

Final Design

The Circuit

The circuit works under the same principle as a Wheatstone bridge. A Wheatstone bridge operates with one parallel branch containing two known resistors and another parallel

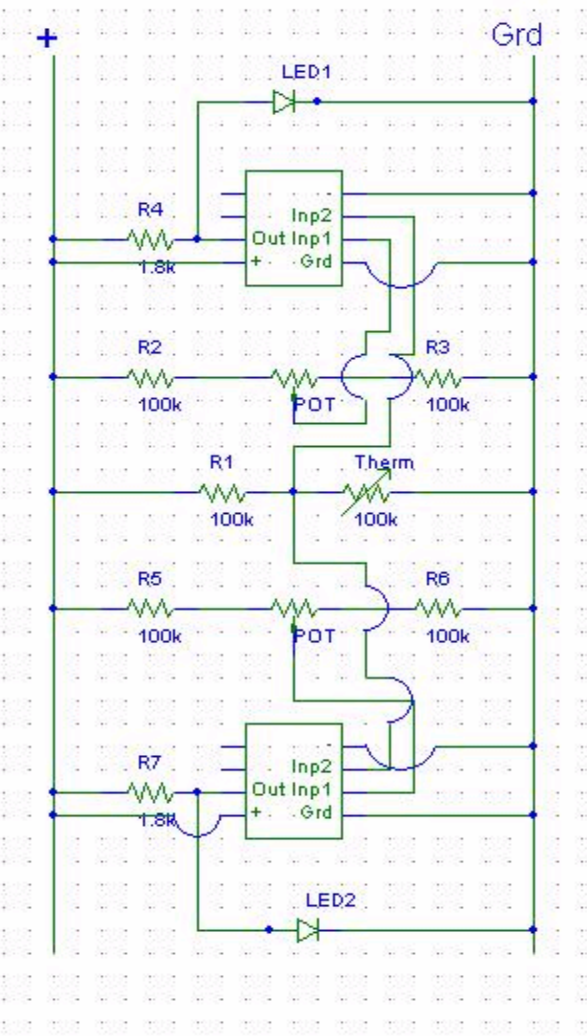

branch containing a known resistor and an unknown resistor. This circuit allows the user to measure the resistance of the known resistor, if the bridge is balanced no current passes through the circuit. In our circuit, the unknown resistor is a thermistor, which changes resistance based on the external temperature. This will allow the device to be used to measure temperature change. The whole circuit is powered by a 9 V battery and contains a switch to conserve the battery when not in use. There are two branches of the circuit, one for the temperature when it is 0.5 ° C too warm and one for the temperature

Fig 6. Circuit Layout

when it is 0.5 ° C too cold from the desired

temperature of 37 ° C. Each branch contains a comparator, two 100 kΩ resistors and a potentiometer. They also contain a LED and a 1.8 kΩ resistor. These two branches are each

connected in parallel to the branch containing a 100 kΩ resistor and 100 kΩ thermistor. The circuit layout can be seen in Figure 6.

In each branch the potentiometer is adjusted so that the branch equals the resistance of the branch with the thermistor when it is at the desired temperature of 37 ° C. The comparator has two inputs. One is connected to the branch with the potentiometer and the other input is connected to the branch containing the thermistor. On one comparator the thermistor branch is connected to input pin 2 and the potentiometer branch is connected to input pin 3. On the other half of the circuit these inputs are reversed. This allows one half of the branch to alert the user when the external temperatures are too warm and the other half to alert the user when the external temperature is too cold. For temperatures that are 0.5 ° C too warm, the potentiometer branch is connected to input pin 2 and the thermistor branch in connected to input pin 3. For temperatures that

are 0.5 ° C too cold, the thermistor branch is connected to input pin 2 and the potentiometer branch is connected to input pin 3. The LED and 1.8 kΩ resistor are connected to the output pin 6.

The LED is then connected to the ground, and the

resistor is then connected to the positive power supply. When the two inputs match, the comparator is short circuited and no current passes through the LED. When the temperature deviates from 37 ° C, the comparator's short circuit is opened, current is allowed to run through the LED, and the light turns on alerting the user. The layout of a comparator can be seen in Figure 7. Pin 1 and pin 4 are connected to ground while pin 5 is connected to the positive bus. Pin 7 and pin 8 are balance pins, and as they are not needed in our circuit, were

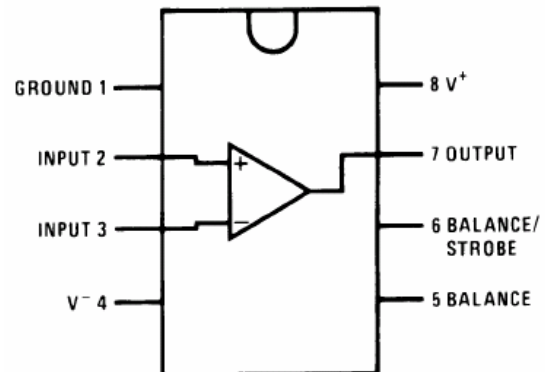

Fig 7. Comparator

left disconnected. In order to differentiate between being too hot or too cold, a red LED will be used for an increase in temperature and a green LED will be used for a decrease in temperature.

When designing our circuit board we started by laying out the circuit so that none of the lines overlapped each other. This way we would not require any jumps. We then drew a mirror image of the circuit so that filled in circles indicated where circuit elements would be soldered to the board and lines were our wires. The design was then transferred to a copper plate, 1.5" x 2". The lines were drawn on the plate with a resistive ink marker. Once complete the plate was soaked in ferric chloride until the excess copper was removed. Any excess copper that was not removed from soaking the board was sanded off. Holes were drilled into the board where the circles were to allow the pins and wires from the circuit elements to be soldered to the remaining copper. All of the elements were placed directly on the board except the battery, switch, and thermistor. Leads to the battery ran from the positive and ground side busses running along the side of the circuit board. From the ground side the switch is attached to the lead and then it is attached to the battery. These elements did not get attached directly to the board because they needed to be manipulated to fit into the circuit casing. The thermistor was attached to the board using 2" copper wires to allow it to be placed in the probe at the end of the casing.

The way in which the LEDs are connected in conjunction with the comparator results in current being drawn from the battery any time the device is switched on. Because of this the battery life of the device is lower than desired. The current drawn can be decreased by increasing the value of the resistor in parallel with the LED, although the tradeoff is that the brightness of the LED is decreased. An acceptable balance between brightness and current

draw was achieved with a resistor value of $1.8\text{ k}\Omega$. When one of the LEDs is on, the current drawn from the battery is 10.1 mA , this value decreases slightly when the LEDs are off. A 9 V battery with a storage capacity of 1200 mAh will result in a total battery life of about 120 hours.

Casing

The final design, seen in Figures 8 and 9, is a piece of PVC pipe that is closed by caps.

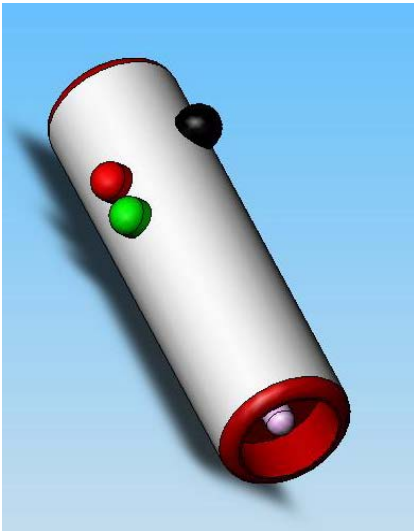

Fig 8. Final Case View 1

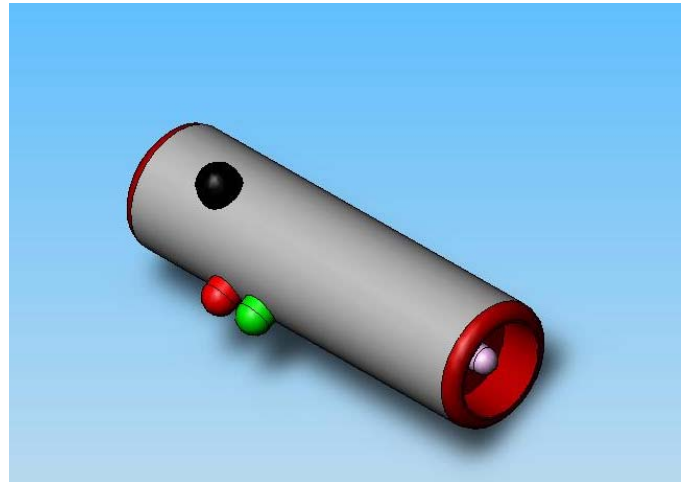

Fig 9. Final Case View 2

The LEDs and the button are sticking out of the shaft of the PVC. These are lined with epoxy to waterproof the holes. A concern that we had with our probe design was that the probe could be damaged by typical use. To solve that problem, the caps we have go into the tube of the PVC. In one end of the PVC, we will drill a hole where the thermistor will be exposed to the medium it is testing. This end of the PVC needs to be submerged in the water so the thermistor can sense the temperature change. The end will also be lined with epoxy to ensure that no water can enter the casing through the opening where the probe exits. Epoxy used within our system should resist up to $120\text{ }^{\circ}\text{C}$, so well beyond the temperature of the water

baths and storage conditions. The size of the PVC tubing is 1.5 inches outer diameter and 3 inches height. Given the size of the circuit board and the size of the battery, we met the size requirements for length, but the width is larger than the 1” requirement. The other cap of the prototype will not be lined with epoxy, thus making the prototype’s battery removable. This will increase sustainability of the device.

Testing

The casing was tested 3 times; the tests consisted of closing the PVC tubing with the caps solely by pressure and inserting the casing into a water bath. The casing remained within the water bath for 24 hours each time. The casing was weighted down by a 2 lb. weight and was submersed, no water was found in the casing when opened after the 24 hour periods of submersion. Replication of trials concludes that the casing will be water proof on its own and by sealing the submersed side with epoxy will assure a complete waterproof seal.

Calibration did not take place until after all of the circuit elements were placed on the board. A water bath was heated up to 37 ° C and a thermometer was placed in the water bath to monitor the temperature. At 37 ° C the thermistor was placed in the bath, both potentiometers were adjusted so that both of the LEDs are turned off. Once the circuit was calibrated, it was tested in different water baths. Some were a large deviation from the desired temperature and the others were smaller deviations. A thermometer was placed in each water bath in order to know the correct temperature.

Future Work

The major concern with our device is the battery life. Even though the battery is disposable, we feel that the device should last 500 hours on one battery. One way to try to

prolong the battery life would be to change our circuit so that the results would be the same, but the draw from the battery would be less. Another concern with this is that to be within budget, we had to get a very inexpensive battery. Perhaps if a larger budget for batteries would be given, the battery life could be extended that way instead of changing the circuit. From here we would have to contact our client and EWH to see which direction we would go in order to extend the life of the battery in the system.

It would also be desirable that this device be a little smaller, as it is currently a bit out of the size range specified by EWH. The diameter is too large, but the integration of a dual comparator will decrease the size of the circuit by decreasing the number of elements. Another way to decrease the size would be to find end caps that are not as deep as the current ones. Currently, they take up more space than necessary. We feel if the size of the device was decreased, it would be more comfortable to use.

Conclusion

Our design meets the requirements given to us by EWH. It measures the deviations off of the given temperature of 37 ° C. It alerts the user of deviation by illuminating a red LED for 37.5° C and above and by illuminating a green LED for 36.5° C and below. It also meets the cost requirements. The final cost of the device is \$3.02 for the components and manufacturing costs. The budget for the device was made by determining the cost for 500 units. The final parts and total costs can be seen in Appendix B.

References

- Allina Hospitals & Clinics. (2005, March). *Laser Lithotripsy*. Retrieved February 12, 2006 from Http://www.allina.com/ahs/laser_hospital.nsf/page/lith
- Caplugs. (2003). *PDE series*. Retrieved April 7, 2006 from <http://www.caplugs.com/catalog/StarPage.asp>
- Castle Wholesalers. (2004). *PVC Pipe 1 1/2" x 10'*. Retrieved April 23, 2006 from http://castlewholesalers.com/cat_list.cfm?category=Plumbing%20Fittings&subcat=Pipe%20%26%20Pipe%20Fittings%20%2D%20PVC%20%26%20CPVC&subsubcat=PVC%20Pipe
- Circuit Specialist, Inc. (2003). *Online Catalog: circuit board 6" x 9", Etching Powder, Flux Remover Pen*. Retrieved April 23, 2006 from <http://www.web-tronics.com/copcladboard6.html>
- Control Company. (2006, January). *Traceable Alarm Thermometer/Alarm Timer*. Retrieved February 5, 2006 from <http://control3.com/4147p.htm>.
- Discount Office Supply. (2003). *Sharpie Marker*. Retrieved April 24, 2006 from <http://www.discountofficesupplies.com/ce/shop/ui>
- Engineering World Health. (2006). *Proposed Projects*. Retrieve January 25, 2006 from www.ewh.org.
- FW Online. *Latex*. Retrieved April 24, 2006 from <http://www.fwonline.com/lftbands.htm>
- Jameco Electornics. (2005). *Online Catalog*. Retrieved March 15, 2006 from www.jameco.com
- New York Distributors. (2006). *Panasonic Batteries: 9-volt*. Retrieved April 15, 2006 from <http://www.cheapbatteries.com/panasonic.htm>

Pacific Link. (2005, September). *Incubators*. Retrieved February 12, 2006 from

[Http://www.biopacificlink.com/pro_incu_incubator.html](http://www.biopacificlink.com/pro_incu_incubator.html)

Research Products International Corporation. (2006). *Alarm Thermometer Monitor*.

Retrieved February 5, 2006 from http://www.rpicorp.com/products/prod_info.htm

[l?products_front_id=995&catid=5&cat_id=78](http://www.rpicorp.com/products/prod_info.htm?products_front_id=995&catid=5&cat_id=78)

Superkleen Direct. (2005). *Epoxy*. Retrieved April 26, 2006 from

<http://www.superkleendirect.com/index.asp?PageAction=VIEWPROD&ProdID=>

[87](http://www.superkleendirect.com/index.asp?PageAction=VIEWPROD&ProdID=87)

ThermoWorks. (2004, November). *Low Cost Digital Thermometers*. Retrieved February 5,

2006 from http://thermoworks.com/products/low_cost/index.html

Webster, John G. (2003). *Bioinstrumentation*. Indianapolis, IN: John Wiley & Sons Inc.

Appendix A

Project Design Specifications:

1. Physical and operational characteristics

- a. *Performance requirements*: When in use, the device will need to be functioning continuously and accurately. It must make user aware of deviation of more than 0.5 ° C from required temperature (37 ° C).
- b. *Safety*: The device should not pass more than 10 μ A through the water, so as to not harm any living tissue that will be in the water bath. The casing for the device should also withstand temperatures of 50 ° C.
- c. *Accuracy and Reliability*: The device should be able to detect temperature change of 0.1 ° C.
- d. *Life in Service*: The device, not including battery, should be able to last two years of daily use, eight to ten hours per day. The battery should last approximately 50 hours.
- e. *Shelf Life*: Device should last at least five years, while the battery should last one year under ambient conditions of temperatures ranging from 0 – 40 ° C.
- f. *Operating Environment*: 17 - 45 ° C. The device can be used while fully submersed in water.
- g. *Ergonomics*: Hand held size, lightweight, portable.
- h. *Size*: Maximum size 1”x 1” x 4”, internal circuitry will not be accessible for maintenance because of coating.
- i. *Weight*: optimum weight is less than half a pound ~230 grams.
- j. *Materials*: Water resistant materials for coating, other restrictions include economically affordable materials that are temperature resistant up to 50 ° C; materials should also be reliable - allowing for a shelf life of five years.
- k. *Aesthetics, Appearance, and Finish*: The device should be compact, rectangular, and have no sharp edges.

2. Production Characteristics

- a. *Quantity*: One initial prototype, if successful and desired by client, the client will need 500 units.
- b. *Target Product Cost*: Total costs for mass manufacturing should not exceed \$3.00 per unit.

3. Miscellaneous

- a. Standards and Specifications: N/A
- b. Customer: Fully submersible, affordable, reliable, heat resistant
- c. Patient-related concerns: Safety for children within water baths, there can be no more than 10 μ A passing through the water.
- d. Competition: There are several digital thermometers on the market with audio/visual alarms, however these are all well above our price range, ranging from \$15-35.

Appendix B

Parts List and Budget

Part	Description	Price/unit	Company	Part number
Comparator	<i>Dual</i>	0.17	Jameco	24281
Resistor	<i>100K</i>	0.0213	Jameco	29997CB
Resistor	<i>1.8K</i>	0.0114	Jameco	29807
Potentiometer	<i>5K</i>	0.5	Jameco	94713CK
LED	<i>Red</i>	0.06	Jameco	333868CB
LED	<i>Green</i>	0.063	Jameco	333201CB
Thermistor	<i>100K</i>	0.32	Jameco	206990CB
Switch	<i>Push-Button</i>	0.35	Jameco	26622CB
Tubing	<i>PVC 1 1/2"</i>	0.144	Castle Wholesalers	1 1/2" x 10'
Caps		0.0724	Caplugs.com	PDE-16
Battery	<i>9 Volt</i>	0.4	Cheapbatteries.com	Panasonic
Circuit Board	<i>Single sided</i>	0.2714	Web-tronics.com	6" x 9" (612)
Battery Clip		0.19	Jameco	11280PS
Copper Wire		.01	Jameco	36855
Epoxy	<i>Clear Coat</i>	0.41922	Superkleen Direct	DEV14310
Rubber /Plastic	<i>Cover for button</i>	0.00098	Fitness Wholesale Online	LRC08
FeCl	<i>etching powder</i>	0.0119	Web-tronics	415-115G
pen	<i>sharpie</i>	0.00114	Discount Office Supplies	Black Sharpie
flux remover pen		0.0096	Web-tronics	4140-P
TOTAL		3.02634		