

## Problem Definition

### Motivation:

In the last ten years, 123 firefighter deaths have occurred due to asphyxiation [2]. These deaths may have been preventable had other firefighters been aware that a choking colleague was in need of aid. It is necessary to develop biometric technology that will monitor the breathing patterns of firefighters.

There are currently several devices that are designed to monitor firefighter ventilation on the market today. However they are quite expensive, as much as \$8000 per unit [3]. Our aim is to create a simplified device that does not have all the extra functions of current products, but as a result is much cheaper.



Figure 1: The monitoring belt for the VivoMetrics VivoResponder™ [3]



Figure 2: The MSA TxR ICM® Accountability System [4]. The unit with the computer is the sensor and also serves as a miniature display.

### Background:

In order to send a wireless signal to the command center, it is necessary that our chest strap have an output voltage that corresponds to ventilation of the firefighter. Inductance plethysmography is a noninvasive method of measuring ventilation using only expanding and contraction of a chest strap. Inductance is  $L = N\Phi_m/i$  [5], where  $N$  = number of turns in a coil,  $\Phi_m$  is magnetic flux, and  $i$  is current.  $\Phi_m$  depends on cross-sectional area of the strap, relating  $L$  to expansion and contraction of the chest. Our goal is to convert the change in inductance into a change in voltage that can be transmitted.

## Design Criteria

### 1. Physical and Operational Characteristics

- Withstand daily use, easy to put on
- Output a signal corresponding to ventilation.
- Life in Service – 5 years
- Tolerate moisture, temperatures up to 110 degrees Fahrenheit, repeated stretching.
- No slip, minimal rotation
- Materials – knit cotton fabric, Velcro, basic circuit elements
- Smooth so as not to irritate skin, comfortable

### 2. Production Characteristics

- Mass producible design
- Target Product Cost – \$100

## Budget

Item	Cost
PPK8 knit 2 yds @ \$2.50/yd	\$5
Velcro Straps	\$2.99
Tax	\$0.44
Frequency to Voltage Converter AD650	\$15.73
Wire, Resistors, Capacitors, BJT	Courtesy of BME Department
<b>TOTAL</b>	<b>\$26.06</b>

## Abstract

Ventilation monitors can save lives of firefighters on the job by alerting rescue personnel if breathing stops. These monitors exist but are very expensive - up to \$8,000 each. Our goal was to build our own ventilation monitor in a much more cost effective manner. The most popular method to measure ventilation is inductance plethysmography because it is noninvasive [1]. We built our own monitoring chest strap. The strap we built is connect to a circuit which gives a frequency output proportional to the cross sectional area of the chest. Typical outputs range from 750 to 900 kHz depending on the size of the chest. A frequency to voltage converter gives a voltage output which can be amplified and wirelessly transmitted.

## Final Design

Our final design features a Colpitts oscillator where the inductor has been replaced by a wearable chest strap. As the wearer inhales/exhales, his/her chest expands and contracts, changing the inductance of the band and thus the frequency of the circuit. A frequency to voltage converter processes the signal, which can then be transmitted as desired.

### Design Advantages:

- Minimal, inexpensive components
- Battery can be used for 9 volt input
- Simple circuit
- Easy-to-process signal

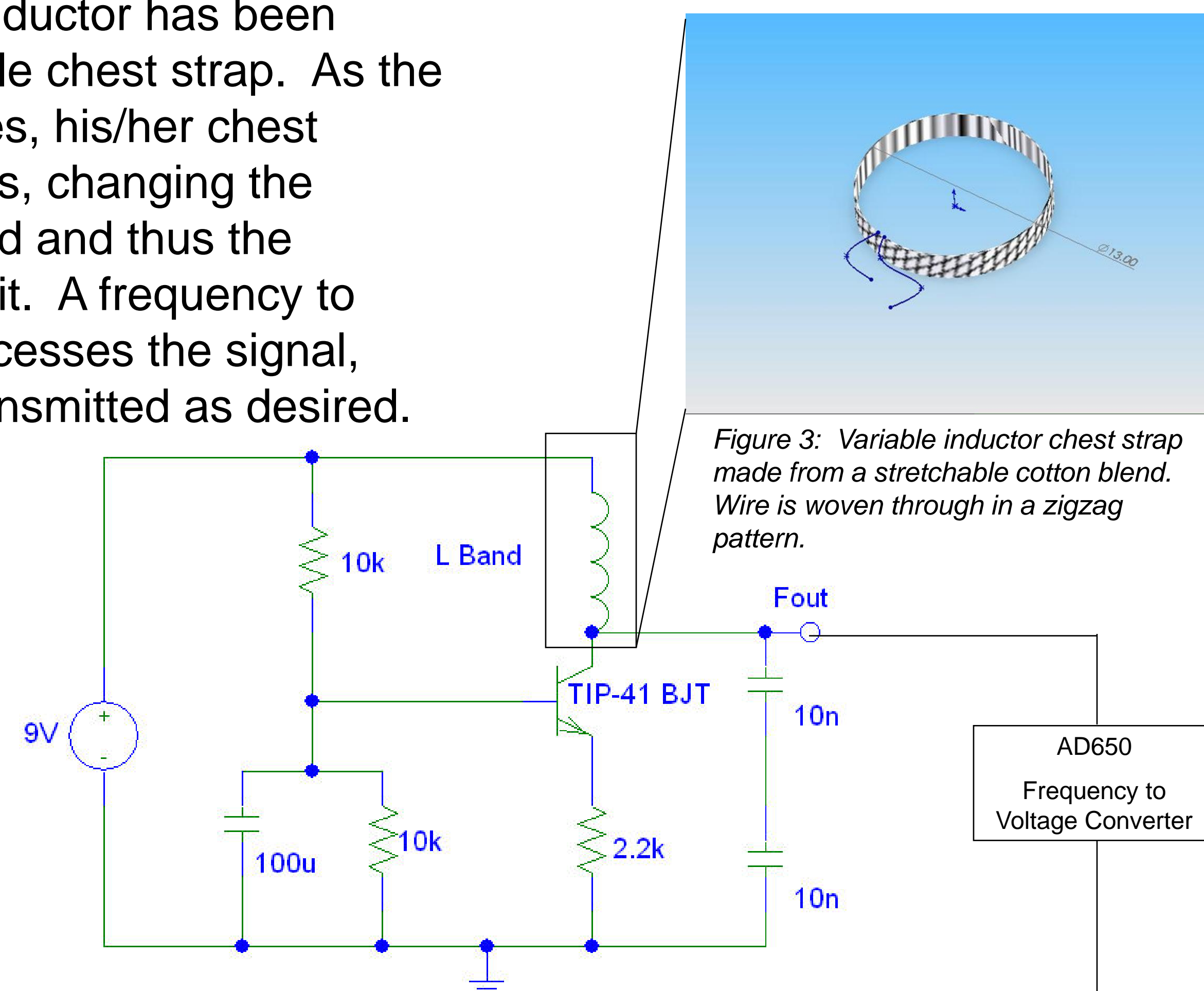

Figure 4: Oscillator circuit that converts a DC input into an AC output whose frequency depends on the inductance of the band

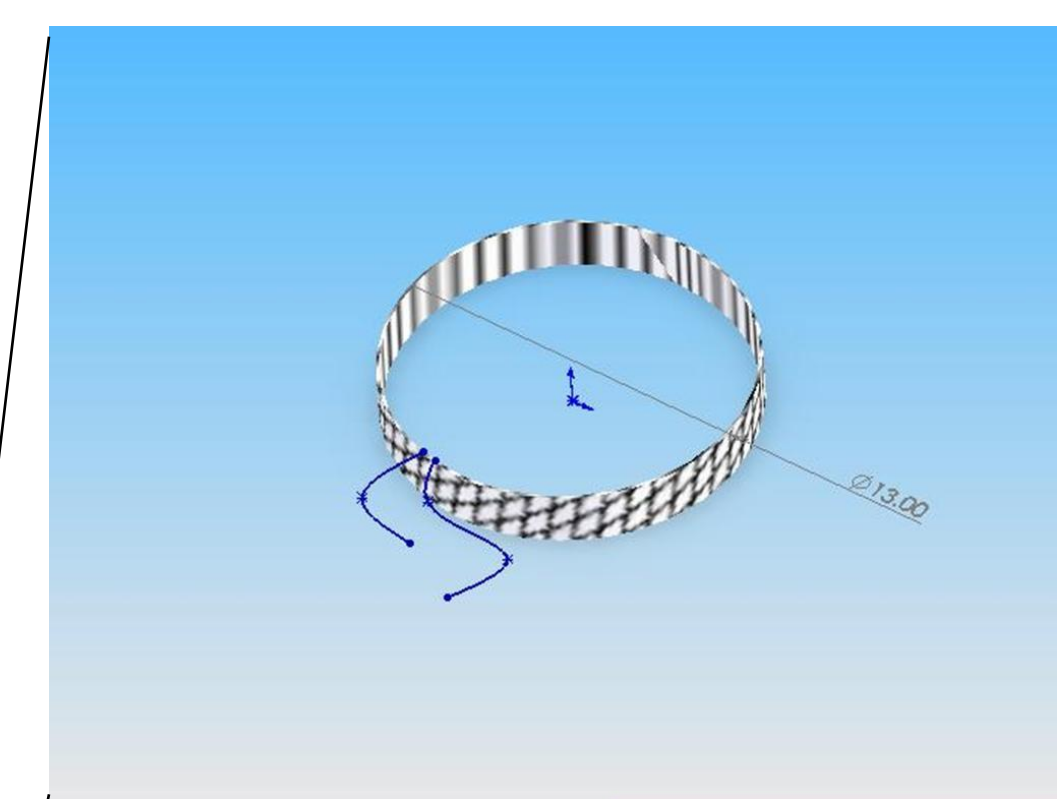

Figure 3: Variable inductor chest strap made from a stretchable cotton blend. Wire is woven through in a zigzag pattern.

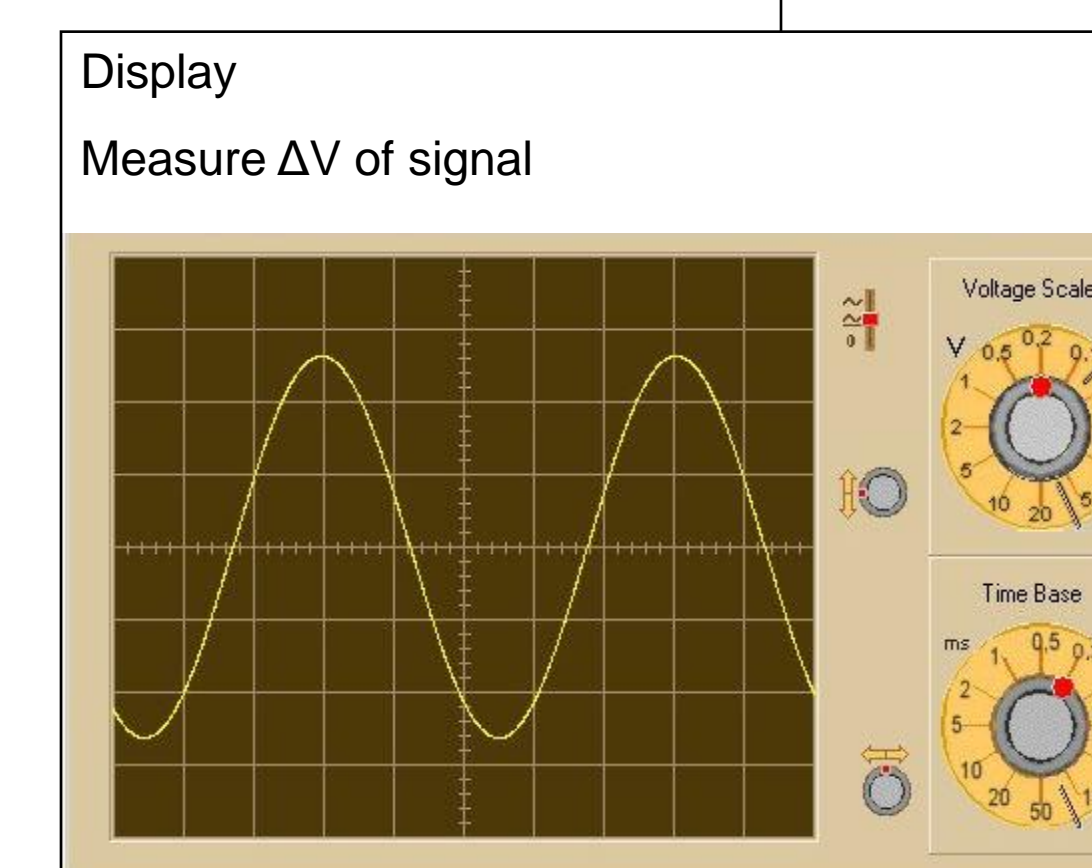

Figure 6: The voltage signal will correspond to a firefighter's ventilation. This output can be transmitted to a command center.

### Design Features

- Colpitts oscillator with L responsive to respiration
- Output signal changes f according to [6]:

$$f_0 = \frac{1}{2\pi\sqrt{L \cdot \left(\frac{C_1 \cdot C_2}{C_1 + C_2}\right)}}$$

## Testing

We tested our circuit with a 9 volt power supply and obtained a frequency that changes if the chest strap user inhales or exhales.

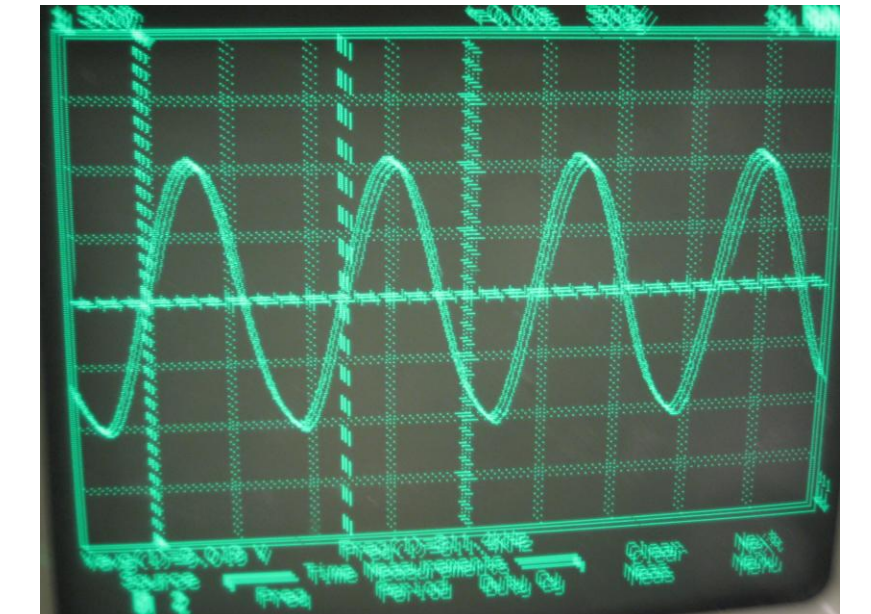
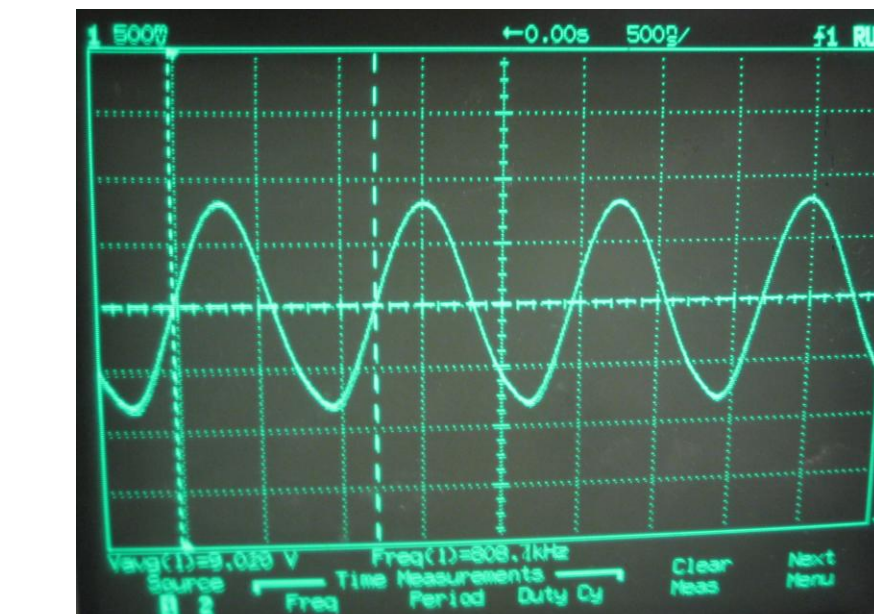

Figure 7: Left – Frequency when the user of the strap exhales. Right – Frequency when user of the strap inhales. There is a difference of about 6 kHz between the two outputs. Both have a DC offset that is approximately equal to the 9 volt input and a peak-to-peak AC voltage of about 1.9 V.

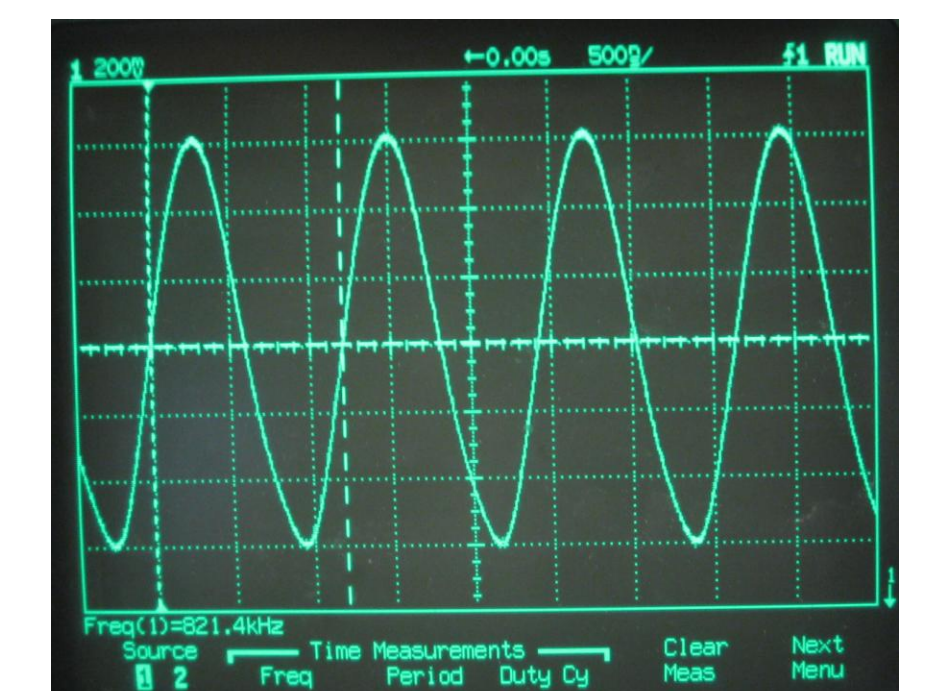
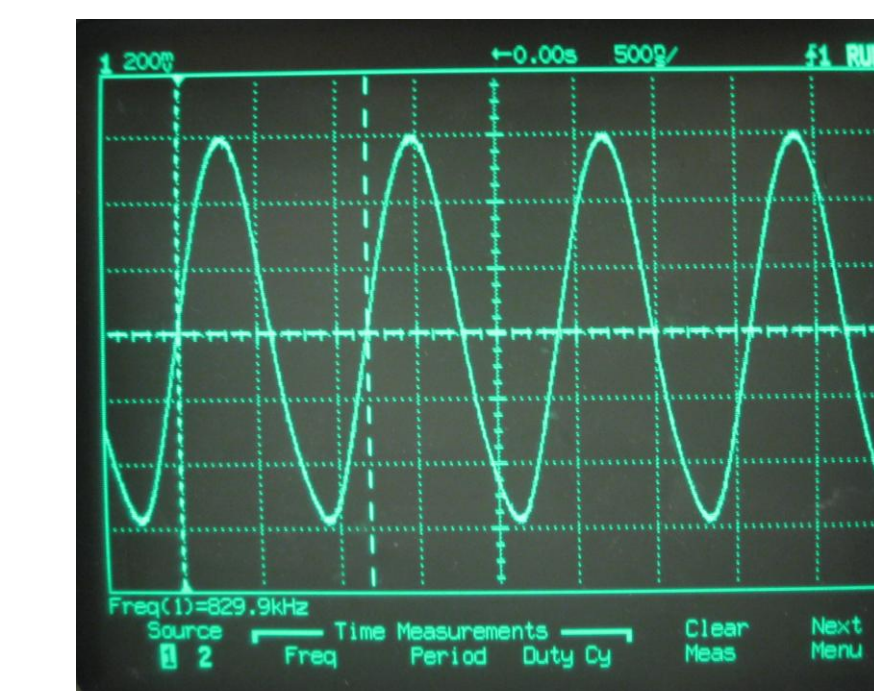

Figure 8: Left – Frequency when a water bottle wrapped in wire is squeezed. Right – Frequency when water bottle is released. The difference in frequency is much more apparent because of a much greater change in inductance. A large number of turns and a smaller cross sectional area results in a greater signal than that from our band, which only has one turn.

We have a chip that should convert this frequency into a voltage, but we cannot currently obtain a signal from it.

## Future Work

- Obtain voltage signal based on volume of chest
- Integrate power sources for f/v converter, operational amplifiers, and oscillator
- Ensure usability for people with different chest diameters
- Test battery life and circuit life
- Purchase circuit component to wirelessly transmit voltage and test radius of transmission

## References

- FireSite. "Firefighters in peril: monitoring heart rate, breathing, and movement." Research Proposal H-SB07.1-005, #0711215.
- U.S. Fire Administration. 2007. "Firefighter Fatalities in the United States in 2006." <http://www.usfa.dhs.gov/downloads/pdf/publications/ff\_fat06.pdf>.
- VivoMetrics, Inc. 2007. "VivoResponder Brochure." <http://www.vivometrics.com/docs/VivoResponderBrochureVGS07.pdf>.
- MSA, Inc. 2006. "ICM® TxR Accountability System." <http://media.msanet.com/na/usa/sar/scbacomplementaryproducts/ICMTxR/0107-15-ICMTxR.pdf>.
- Senway, Raymond A. and Jewett, Jr., John A. 2004. *Physics for Scientists and Engineers*. Brooks/Cole, Belmont, CA.
- Cohen et al. 1994. "Design of an Inductive Plethysmograph for Ventilation Measurement." *Physiological Measurement*. Vol 15, No 2, pp 217-229.

## Acknowledgements

Special thanks to Professor and Mrs. Webster, Burke O'Neal, Dr. Steve Weber, Justin Rosenthal, Steve Skroch

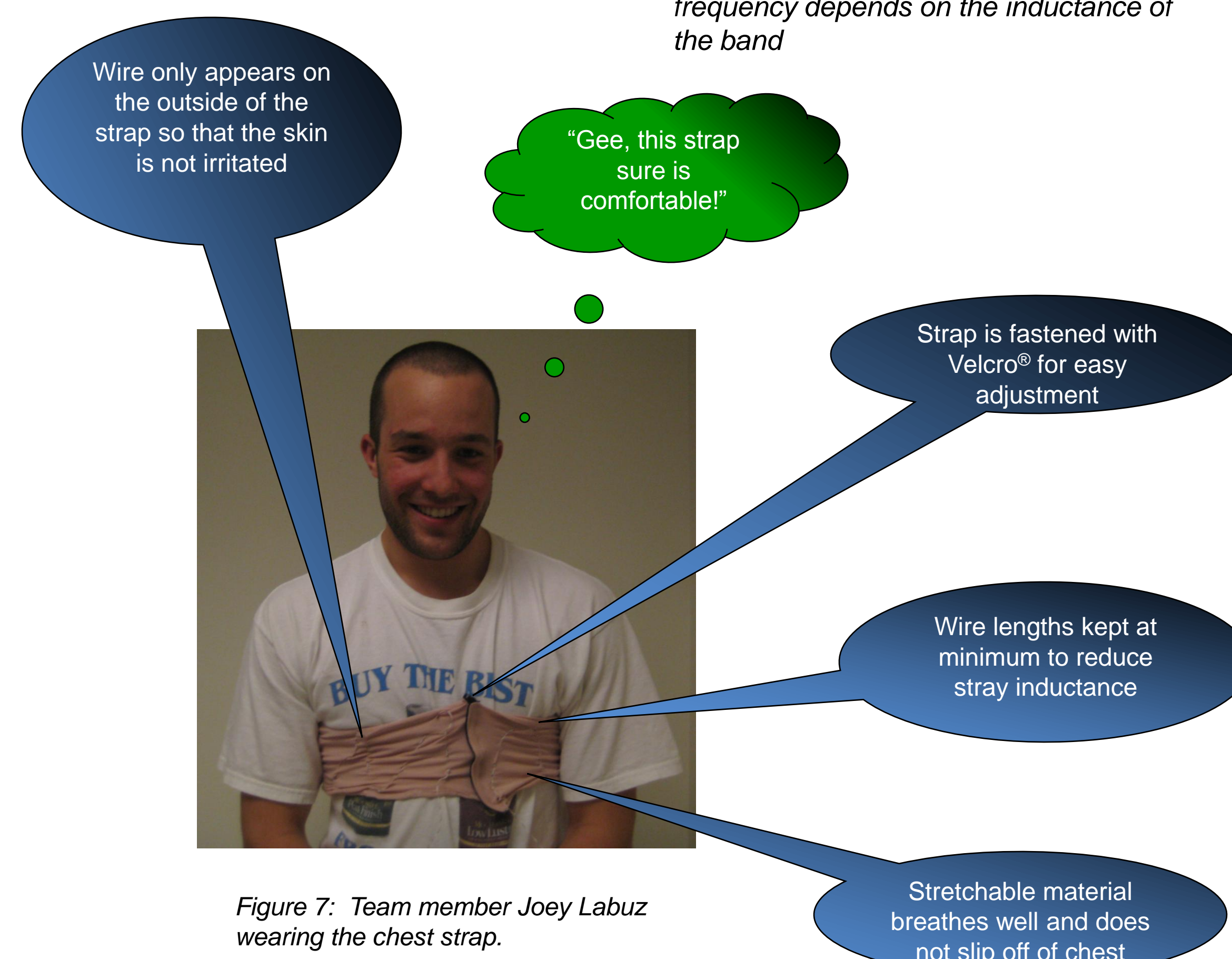

Figure 7: Team member Joey Labuz wearing the chest strap.