

Chris Besaw, Ben Smith, Don Weier, Stephen Young

Clients:

Dr. Amit Nimunkar, Department of Biomedical Engineering – University of Wisconsin Madison  
Engineering World Health

Advisor:

Dr. Paul Thompson, Department of Biomedical Engineering – University of Wisconsin Madison

## Abstract

Sudden Infant Death Syndrome (SIDS) is the sudden, unexplained death of an infant under the age of one, usually while sleeping. There are over four million neonatal deaths yearly, with over 99% of these deaths occurring in low to mid income nations. Respiratory monitors have been shown to decrease the number of infant deaths while sleeping, but current models on the market are too expensive and energy dependent to be effective for wide-spread implementation in developing nations. The team has developed a prototype respiratory monitor that utilizes impedance pneumography to detect breathing. The monitor has significantly reduced power consumption and initial and recurrent costs, so it can feasibly be implemented in developing countries. A PIC18F14K22 has been selected as a low power microcontroller, and two rechargeable lithium ion battery are integrated as the power source to allow for easy recharging. Through rigorous testing, the monitor has been shown to successfully set off an alarm system, audible from over 200 feet, reliably with correct electrode placement. A charging circuit and electrode belt need to be included in the future, as well as cost and size reduction.

## Problem Definition

### Motivation

- Sudden Infant Death Syndrome (SIDS)
- 4 million neonatal deaths per year
- Mobile clinic setting in impoverished areas
- Expensive medical equipment not an option
- Latent demand for apnea monitors in developing countries: \$94.11 million

### Current Designs



• All models > \$100

## Problem Statement

• Need for an inexpensive device that will reliably alert caretakers if an infant ceases to breathe

## Design Criteria

- Sound alarm in event that breathing ceases for 20 seconds
- Highly reliable
- Safe to operators and infant
- Low cost
- Power efficient
- Portable
- Robust
- Simple to operate
- Suitable for use in third-world countries

## Final Design

### Signal generation and signal processing circuit:

- Quadrature oscillator
- Instrumentation amplifier
- Envelope detector

### Microchip: PIC 18F14K 22-I/P

- Low power
- Low cost
- Determine signal threshold for normal breathing
- Sound alarm when signal falls below threshold for more than 15 seconds

### Power Source: Cell Phone Batteries

- 3.7 V
- 960 mAh
- Calculated battery life of 43 hours
- Ideally, recycle old batteries
- Collect via donation

### Alarm:

- Audible piezo siren

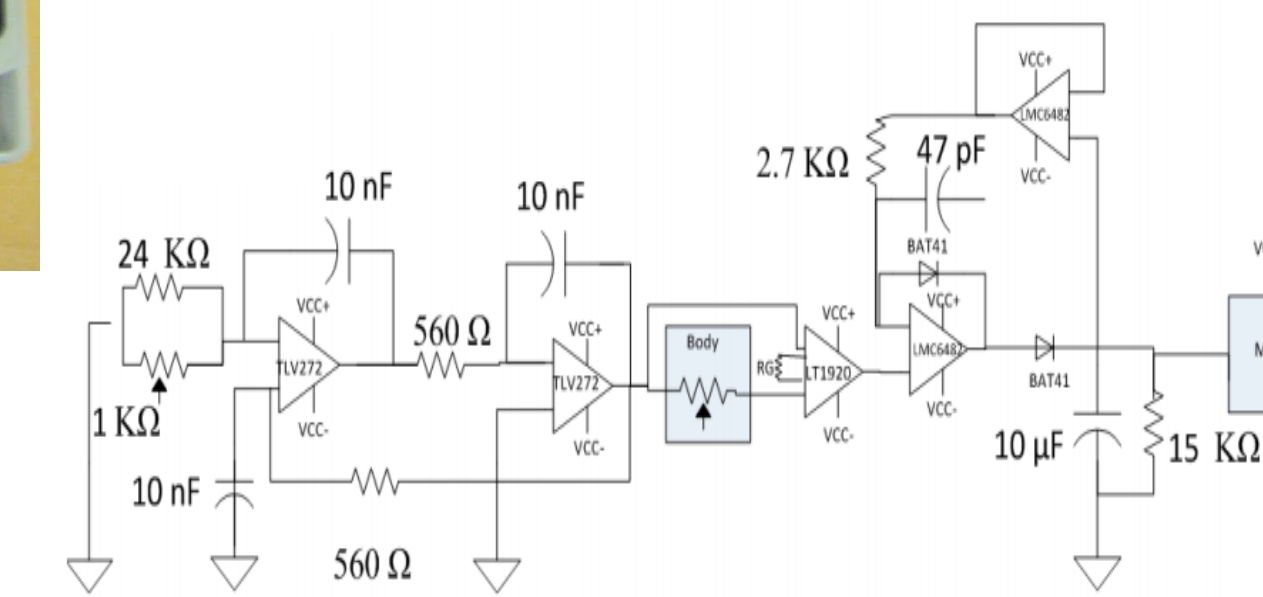
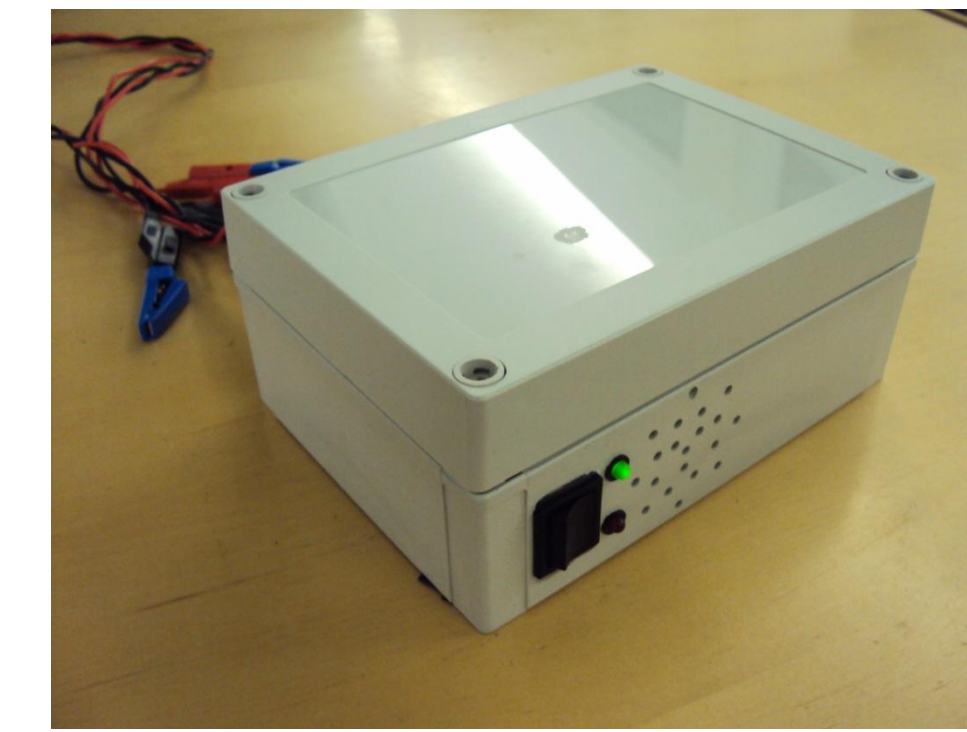
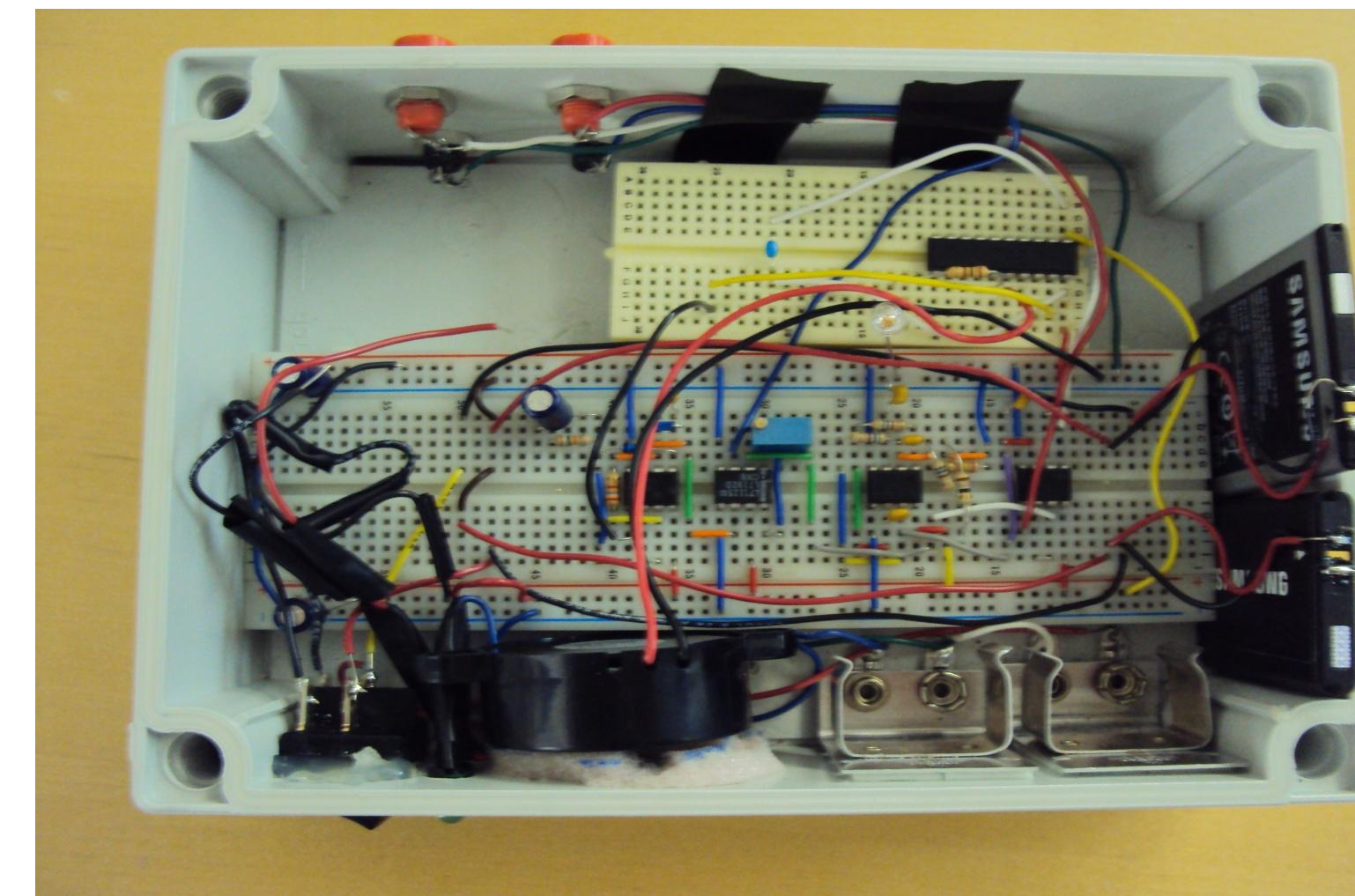

## Testing

### Electrode Placement

- Determine best electrode arrangement

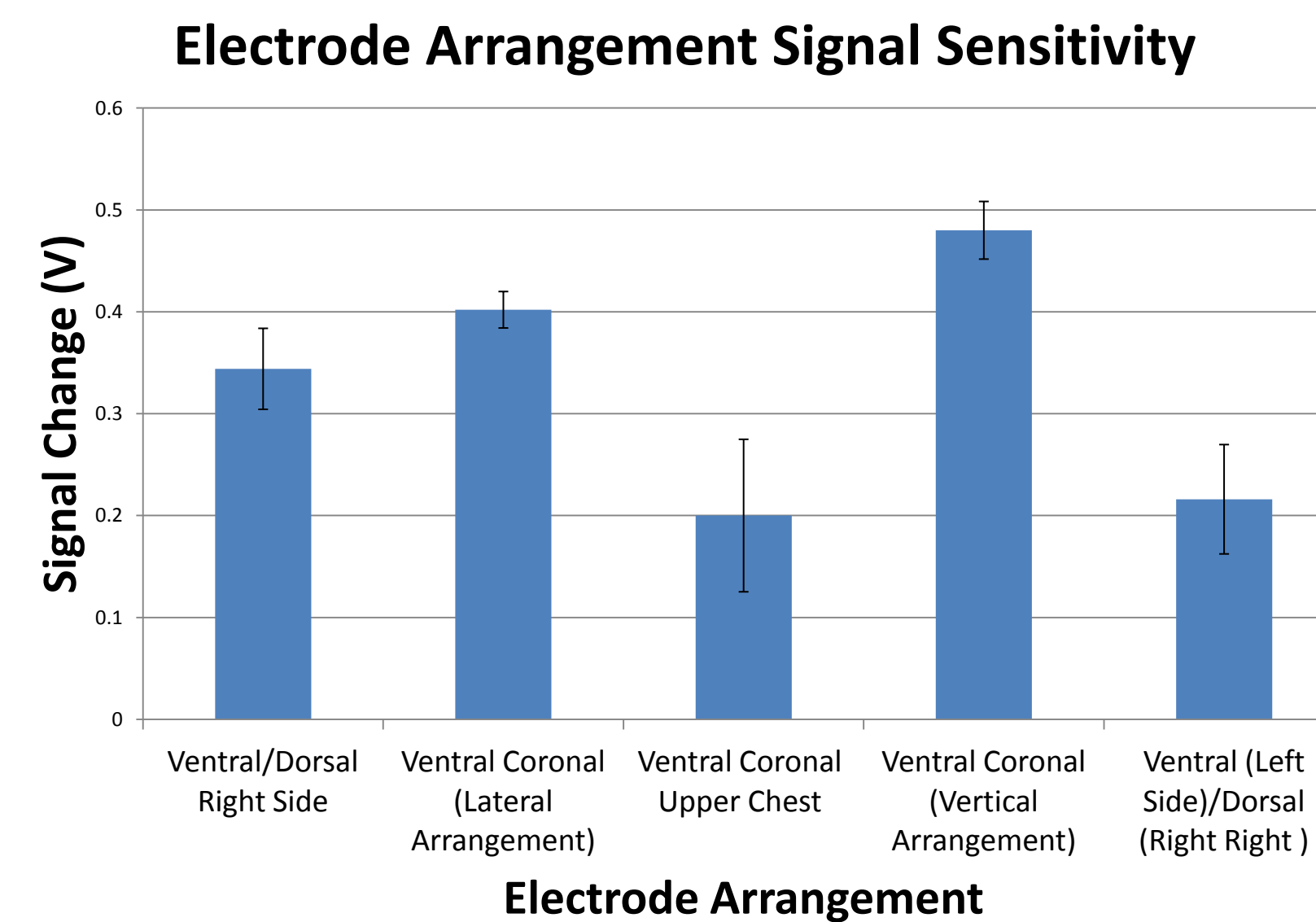

### Proper Electrode Placement

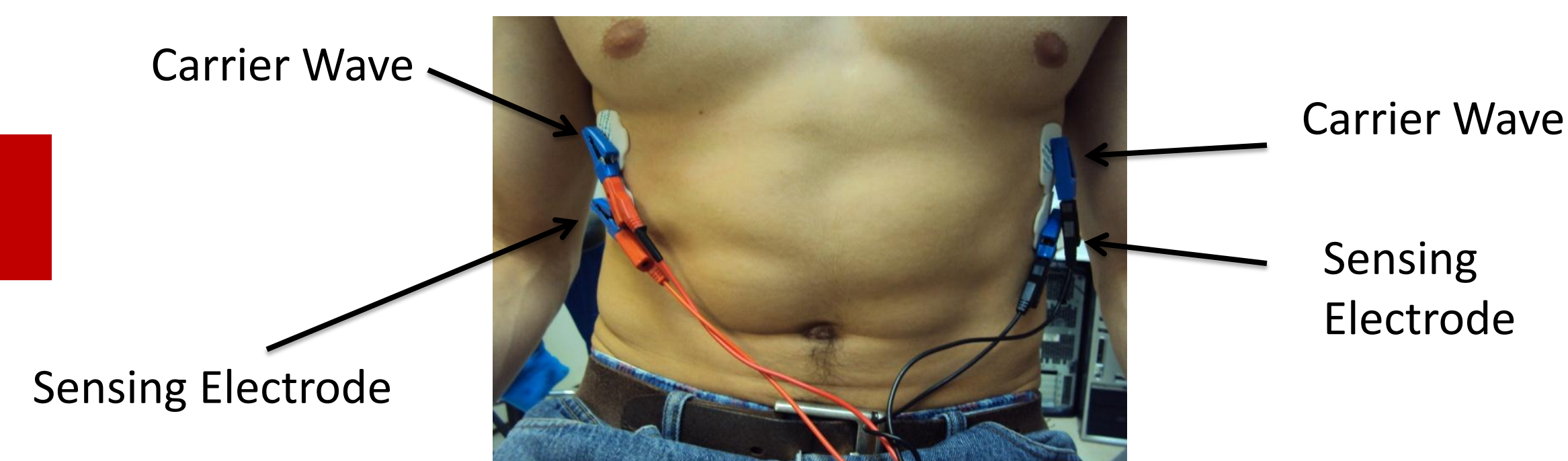

### Alarm Strength

- Ensure siren can be heard from various distances
- Tested at 50, 100, 150, and 200 feet
- Clearly audible at all distances

### Signal Testing

- Instrumentation amplifier output to envelope detector:

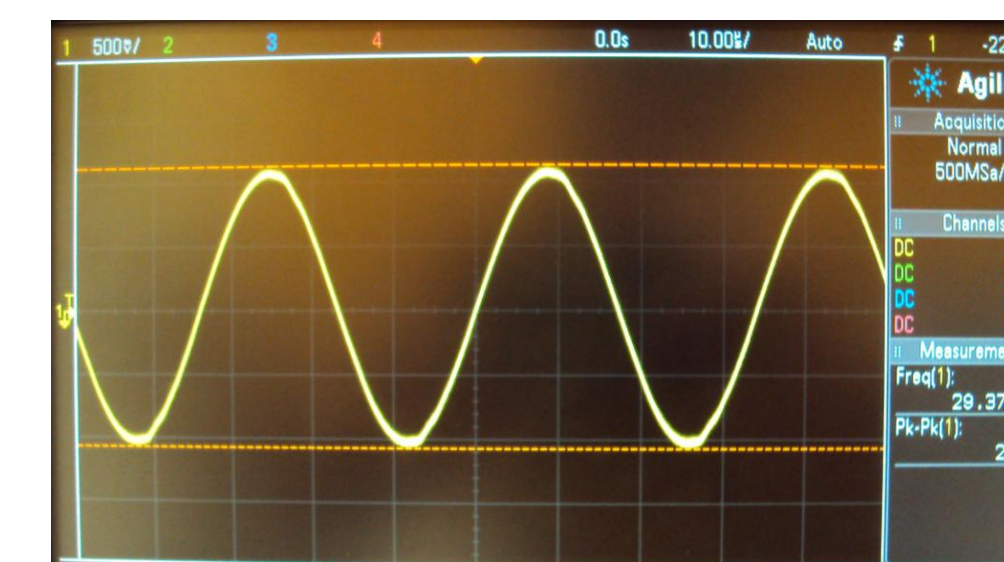

- Determine relationship between lung volume changes and electrical signal

### Lung Volume Change vs. Signal Change

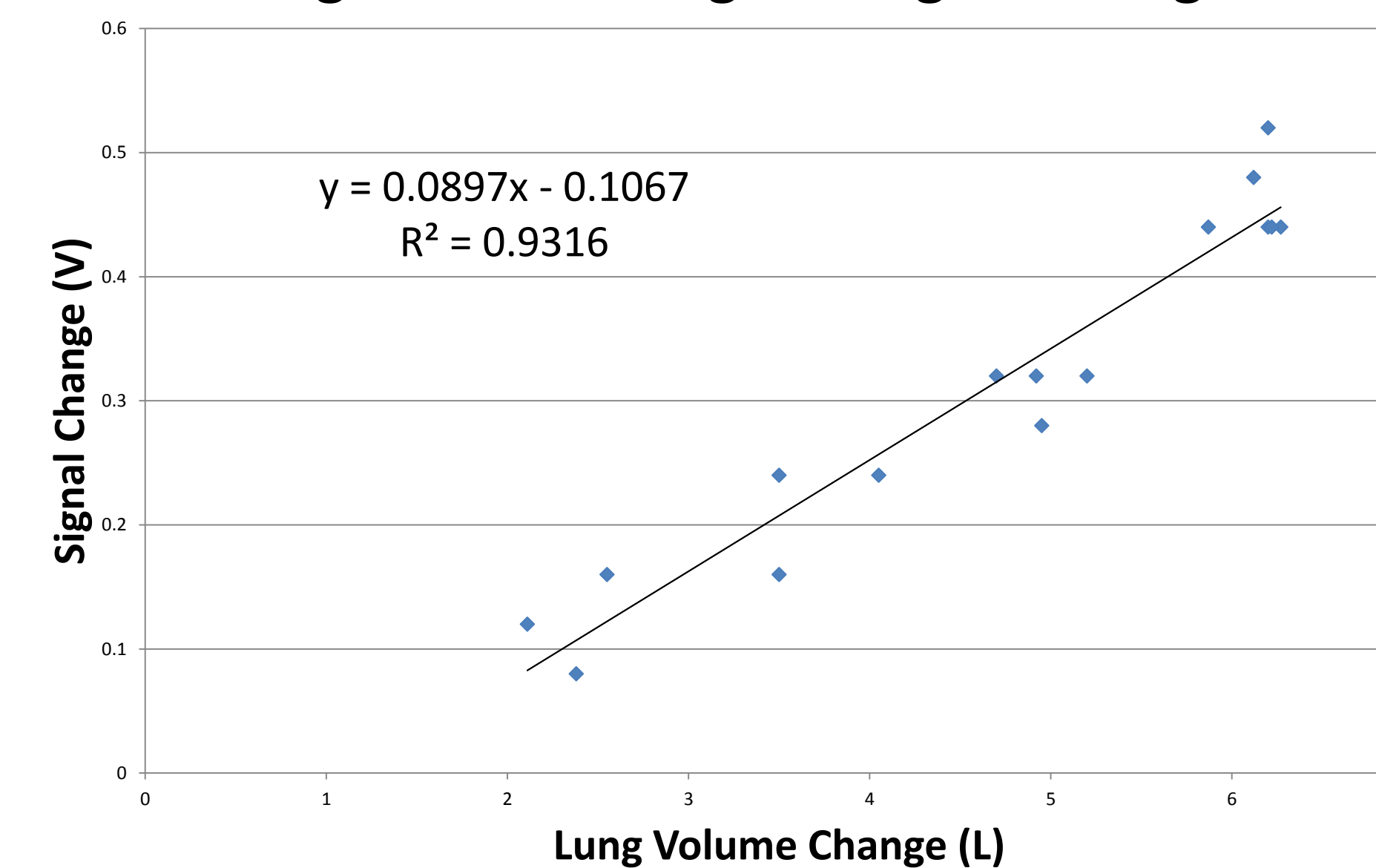

### Alarm Reliability

- Ensure alarm sounds when breathing ceases
- Measure time between cessation of breathing and sounding of alarm
- Results: Average time between breathing cessation and alarm was

14.30 ± 0.36 seconds

## Parts List

Resistors.....	\$0.05
Capacitors.....	\$0.36
Operational Amplifiers.....	\$0.38
Breadboard.....	\$4.00
PIC 18F14K 22-I/P Microchip.....	\$1.71
Piezo Siren.....	\$5.79
Housing.....	\$4.49
Cell Phone Batteries.....	Donated
LEDs.....	\$0.04
Banana Plugs.....	\$7.00
Electrodes.....	\$0.72
On/Off Switch.....	\$0.52
Cell Phone Battery Charger*.....	\$5.00

Total: \$30.06

\*Can be used in multiple units

\*\*Prices were estimated for bulk purchases

## Future Work

- Integrate battery charging circuit into monitor
- Design electrode belt
- Test on infants
- Print circuit on board
- Improve device sensitivity
- Organize large-scale battery collection/donation
- Reduce size of device
- Fatigue testing both in shipping and in use
- Improve battery housing

## References

- Sudden Infant Death Syndrome. Retrieved 3/8/12 at <http://www.ncbi.nlm.nih.gov/pubmedhealth/PMH0002533/>
- Sudden Infant Death Syndrome. Retrieved 3/8/12 at [http://www.nichd.nih.gov/health/topics/sudden\\_infant\\_death\\_syndrome.cfm](http://www.nichd.nih.gov/health/topics/sudden_infant_death_syndrome.cfm)
- Home Monitoring for SUDC Siblings. Retrieved 3/10/12 at <http://www.sudc.org/Portals/0/medical/HomeMonitoringForSUDCSiblings.pdf>
- Lawn et al. 4 Million Neonatal Deaths: when? Where? Why?. The Lancet: Volume 365, Issue 9462, 5–11 March 2005, Pages 891–900
- Babysense. Retrieved 3/10/12 from <http://www.hisense.co.il/catalog.php?id=16>
- Microchip. Products Catalog [Online]. <http://www.microchipdirect.com/ProductSearch.aspx?Keywords=DM180021> [Mar. 12, 2012]
- RespiSense. Retrieved 3/10/12 from <http://www.respiSense.com/en/index.php>
- Online. Retrieved May, 1, 2012, from <http://search.digikey.com/us/en/products/ERD-S2TJ301V/P300BATB-ND/503284>.
- Online. Retrieved May, 1, 2012, from <http://search.digikey.com/us/en/products/ECA-1HM3R3B/P10391TB-ND/268476>
- Online. Retrieved May, 1, 2012, from <http://www.mouser.com/ProductDetail/Texas-Instruments/LM2904D/?qs=3pnr37ZAbK%2fufIQSGuUuDMzEn5JQ88LI>
- Online. Retrieved May, 1, 2012, from <http://www.newark.com/jsp/search/productdetail.jsp?SKU=25R0654&CMP=AFC-GB100000001>
- Online. Retrieved May, 1, 2012, from <http://www.mouser.com/ProductDetail/Kingbright/WP3A8GD/?qs=DkZGzo4b%252bTIVvZNYUy5tero325FE7zSPV54u%2ffhz3E%3d>
- Online. Retrieved May, 1, 2012, from <http://www.aliexpress.com/product-fm/545926785-Disposable-Electrodes-For-ECG-EKG-machine-patient-monitor-50pcs-bag-wholesalers.html>
- Online. Retrieved May, 1, 2012, from <http://www.mouser.com/ProductDetail/CW-Industries/NAA-211-BI31-00/?qs=4EnmSMTL3HNVzvbPbUJkDVFVFCyDXuVa>
- Online. Retrieved May, 1, 2012 from <http://www.cellphoneshop.net/univbatcharger.html?CAWELAID=550030630&gclid=CPXpqcDC5a8CFU3UKgodoXe11g>

## Acknowledgements

Matt Bollom, BME Senior, for help with microcontroller programming  
Pete Klomberg, BME graduate student, for circuit consultation  
Dr. Tompkins, BME faculty, for digital filter design help  
Dr. Houser of UW Health for SIDS information  
U.S. Cellular and Battery Plus+ for generous donations