

# Tissue Biopsy Dissociation

Raven Brenneke, Thomas Guerin, Chrissy Kujawa,  
Nate Richman, Lauren Ross



**WISCONSIN**  
UNIVERSITY OF WISCONSIN-MADISON

# Overview

- Problem Statement
- Background
- PDS
- Review of Last Semester
- Designs
- Fabrication Matrix
- Preliminary Testing
- Future Work
- Acknowledgments

# Problem Statement

Dr. Sameer Mathur conducts asthma research and frequently obtains small lung tissue biopsies from patients

Current device being used for tissue dissociation are designed for larger scale specimens of tissue

Small biopsies are not compatible with this device-cells do not dissociate

The team's task: develop a smaller scale device to successfully dissociate a smaller tissue specimen

# Asthma & Lung Biopsies

## What is asthma caused by?

- Airborne allergens
- Inflammatory response led by T-helper type lymphocytes<sup>1</sup>

## How are lung biopsies performed?

- Needle, thoracoscopic, transbronchial, open<sup>2</sup>
- Client does bronchoscopies
  - Fiber optic bronchoscope through airways
  - 1-2 mm tissue

Asthma - Inflamed Bronchial Tube

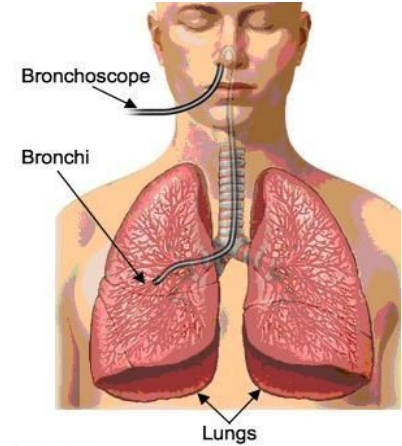
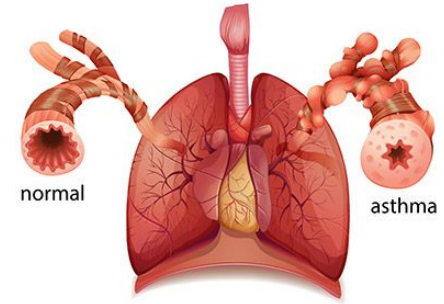

# Product Design Specifications

- Yield at least 10,000 cells
  - Preferably 10,000 eosinophils
- Needs to process tissue sizes of 1-2mm<sup>3</sup>
- Material for the device must be less than \$10 per run
- Materials used and process should not lyse cells or disrupt cell markers

# Review of last semester

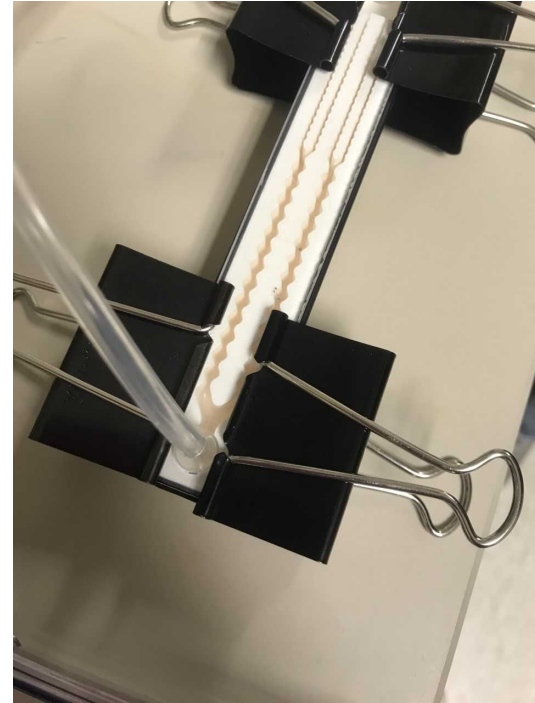
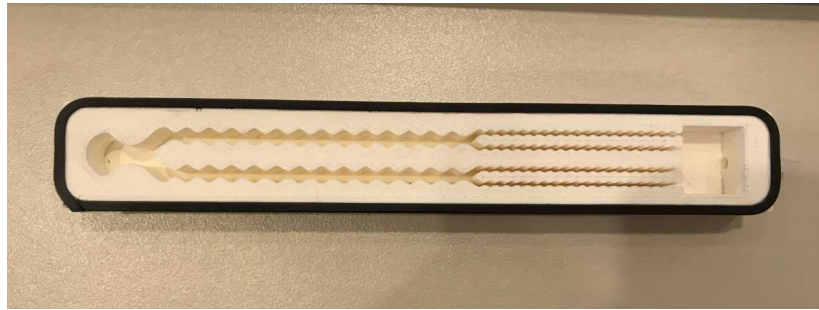

# Competing/Informing Designs

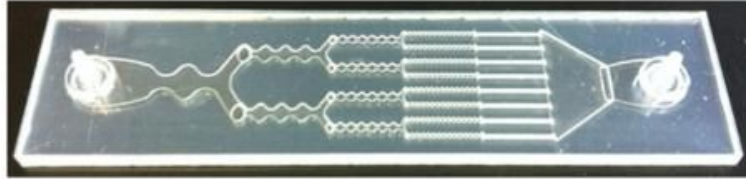

Microfluidic device for dissociation of tumor aggregates<sup>3</sup>

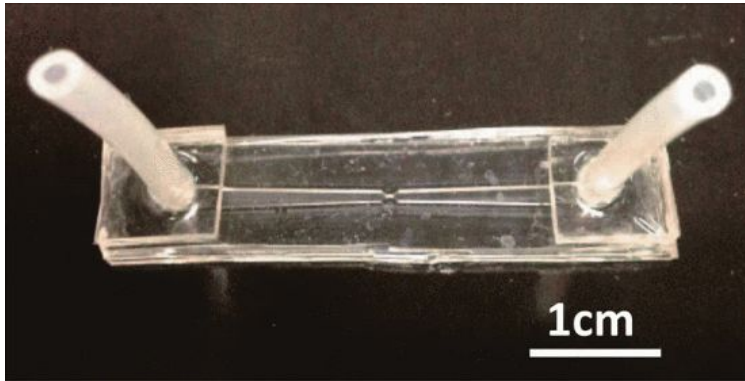

Microfluidic device for dissociation of neurons<sup>4</sup>

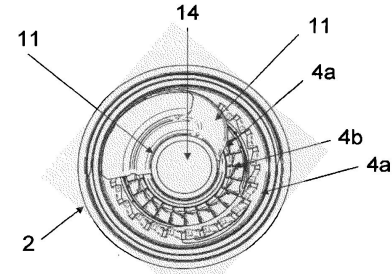
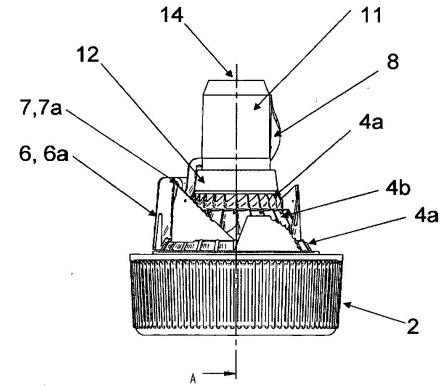

Miltenyi gentleMACS<sup>5</sup>



# Design

Programmable peristaltic pump

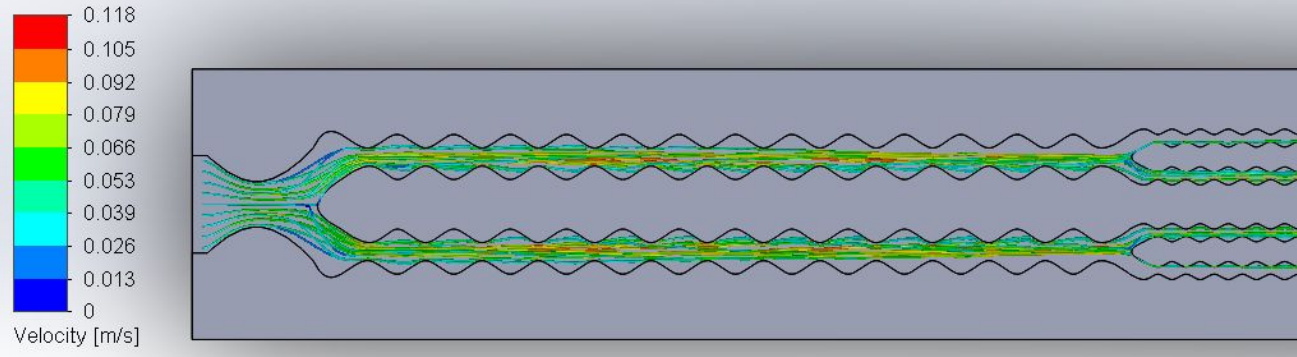
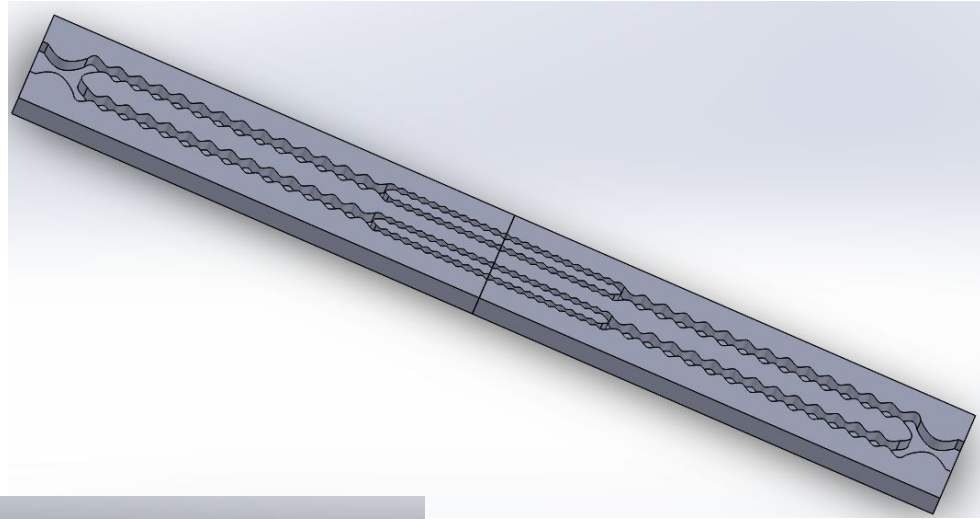
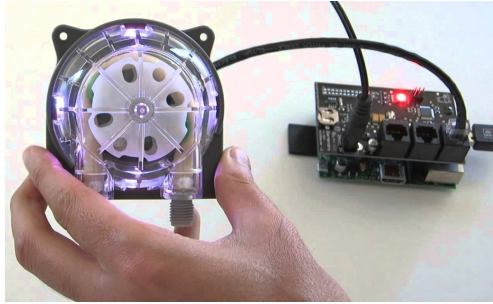



# Fabrication Methods

## 3D printing



## PDMS Photolithography

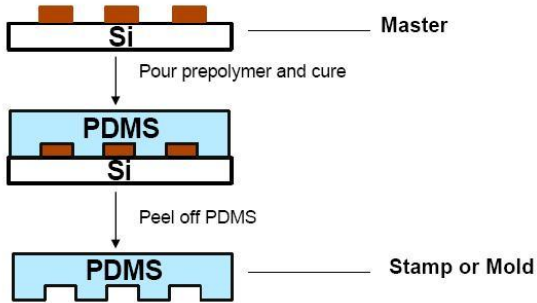

## Laser Cutting



## Micromilling

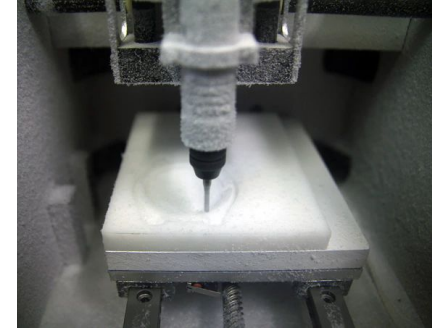

Criteria	3D Printing	PDMS Photolithography	Laser Cutting	Micromilling
Accuracy (35)	28 (4/5)	21 (3/5)	21 (3/5)	35 (5/5)
Materials (30)	18 (3/5)	30 (5/5)	24 (4/5)	30 (5/5)
Ease of Fabrication (20)	20 (5/5)	12 (3/5)	12 (3/5)	8 (2/5)
Cost (15)	12 (4/5)	12 (4/5)	15 (5/5)	3 (1/5)
<b>Total (100)</b>	<b>78</b>	<b>75</b>	<b>72</b>	<b>76</b>

Category Winner

Matrix Winner

# Preliminary Testing

1. Take frozen mouse lung tissue and use biopsy tool to create 2mm sample
2. Incubate in collagenase solution for 30 min. at 37C
3. Place tissue in device
4. Seal device using clamps
5. Run HBSS through device 5 times using peristaltic pump
6. Spin down solution in centrifuge
7. Resuspend cells
8. Count cells

# Preliminary Testing

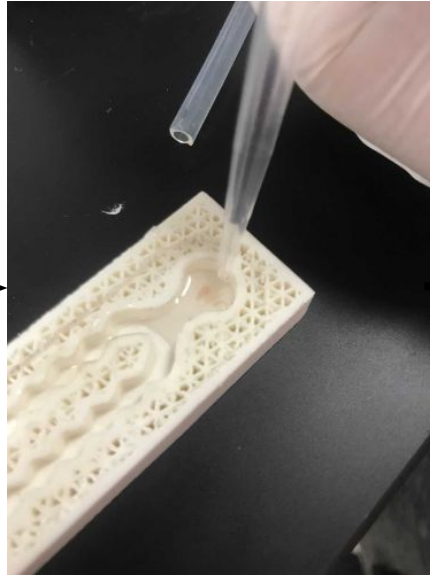

# Future Work

- Overall goal of this semester: Achieve complete tissue dissociation
  - Create a better system of sealing the top
  - Eliminate leaking issues
  - Possibly have closed system
  - Cell count
  - Change channel size/length
- Future semester(s)
  - Cell viability/cytotoxicity
  - Professional fabrication



# Acknowledgements

Dr. Sameer Mathur

Dr. Krishanu Saha

Robert Swader

Elizabeth McKernan

# Questions?

# References

- [1] J. R. Murdoch and C. M. Lloyd, “Chronic inflammation and asthma,” *Mutation Research*, 07-Aug-2010. [Online]. Available: <https://www.ncbi.nlm.nih.gov/pmc/articles/PMC2923754/>. [Accessed: 05-Oct-2017].
- [2] “Lung Biopsy,” *Lung Biopsy | Johns Hopkins Medicine Health Library*. [Online]. Available: [http://www.hopkinsmedicine.org/healthlibrary/test\\_procedures/pulmonary/lung\\_biopsy\\_92,P07750](http://www.hopkinsmedicine.org/healthlibrary/test_procedures/pulmonary/lung_biopsy_92,P07750). [Accessed: 05-Oct-2017].
- [3] Dr. R-P. Peters, Dr. E. Kabaha, W. Stoters, G. Winkelmayr and F. Bucher, “Device for fragmenting tissue,” European Patent Specification #EP2540394B1, May 05th, 2016
- [4] L. Jiang, R. Kraft, L. Restifo et al. “Dissociation of brain tissue into viable single neurons in a microfluidic device,” [Online] Available: <http://ieeexplore.ieee.org/document/7492500/>. [Accessed: 21-Feb-2018].
- [5] Miltenyi Biotec, “GentleMACS Dissociator,” Jan. 1, 2018.