

Research Article
An Improved Method of Securing Surgical Drains

Abdoulahi Bah^a, Dana Stumpfoll^a, Lauren Heller^a, Oscar Zarneke^a, Rebekah Makonnen^a, Dr. Tracy Puccinelli^a, Dr. Kathryn Kalscheur^b

^aDepartment of Biomedical Engineering, University of Wisconsin - Madison, WI, USA

^bDepartment of Civil and Environmental Engineering, University of Wisconsin - Madison, WI, USA

Short Title: Drain Pain

Journal: Breast Care

Corresponding Author:

Dr. Tracy Jane Puccinelli

Department of Biomedical Engineering

University of Wisconsin - Madison

1415 Engineering Drive

Madison, WI, 53706, USA

E-mail: tracy.puccinelli@wisc.edu

Keywords: surgery, bandage, pain, drain, clip, design

Abstract

Background: Mastectomies are commonly performed surgeries to treat breast cancer. Following these procedures, surgical drains are commonly placed and secured with sutures, causing discomfort to the patient. **Methods:** Our team has designed a novel technique for securing a surgical drain that reduces tension at the suture site, thus increasing patient comfort. The drain exit site is surrounded by a hydrocolloid bandage, and the drain is secured to a 3D-printed clip that is attached to the end of the bandage via a waterproof adhesive. To validate this device, extensive testing was conducted consisting of a strength test, to determine how much weight the clip can support, a flow test, to ensure the clip is not obstructing the flow of the exudate, and a wear test, to compare the device to an on the market product. **Results:** Strength testing identified the 0.300 cm clip as supporting the most mass, but flow testing also showed it obstructing drain flow. No other clip obstructed flow and the 0.325 cm clip supported the second-highest mass. Wear testing showed Grip-Lok® performed better from days 1-9.5, but there was no difference in lifespan as compared to our device. **Conclusions:** The combined results of strength and flow testing showed the 0.325 cm diameter clip to be best, supporting the most mass without obstructing flow, validating its use. Grip-Lok® performed better in wear testing, but the testing methods may not have accurately simulated clinical use. Clinical testing is needed to further validate the device.

Introduction

Annually, more than 100,000 mastectomies are performed in the United States; either as a breast cancer treatment or as preventative action (1). Following mastectomies, a surgical drain is typically placed to prevent a build-up of fluid, or a seroma, from forming in the body. Seromas occur when there is a collection or build-up of fluid in an open space or pocket below the skin (2), such as when fluid leaks from damage to the lymphatic system to the space where tissue has been removed through surgery (3). Seromas cause the flaps of the chest wall to elevate and this interferes with the skin's adherence to the tissue bed. This can cause dangerous complications such as delayed wound healing, wound infection, hematoma, flap necrosis, wound reopening, increased hospitalization time, delayed recovery time, and a risk of wound infection which can cause an abscess (4). The most effective postoperative way that seromas can be prevented is through the use of surgical drains (5).

Surgical drains are secured using many different methods based on the surgeon's preference and the equipment available. However, by and large, the most common method involves using sutures. Sutures are tied with various techniques (6–10), but they will all encounter the same patient comfort issue of tugging on the sutures. Tape (9) or disposable adhesive devices (11–13) may be used in place of sutures to increase patient comfort. These techniques, though, only last for approximately one week before requiring removal as the adhesive wears down. This is an issue when the drain must be in place for extended periods, as drainage must consistently be less than 25-30 mL of fluid a day before removal, which can take up to 1-5 weeks (14,15). Therefore, a new method of fixing surgical drains to the body in conjunction with sutures was developed to increase patient comfort when a long-term drain is placed. This new method consists of a bandage that adheres to the skin with a clip attached to it to secure the surgical drain tubing in place.

Materials and Methods

BANDAGE SELECTION

To determine the ideal bandage, the mechanical properties of four different bandages were measured: a hydrocolloid dressing (Winner Medical Co. Ltd., Guangdong China); elastic therapeutic tape (SpiderTech Inc., Toronto, Ontario, Canada); the aforementioned elastic therapeutic tape with an overlaying waterproof adhesive (Nuanchu, Wuhan, China); and a silicone bandage (Medline, Wuhan, China). Since elastic therapeutic tape has fibers running in mainly one direction, both the parallel and perpendicular

orientations were tested to determine if it is an anisotropic material. Poisson's ratio was measured by drawing a square on the unstretched material and measuring the lateral and longitudinal deformations of this square using a ruler. Young's modulus was also determined using the MTS Criterion® Model 43 (MTS Systems®, Eden Prairie, MN, USA). From these, the shear modulus was calculated, and these mechanical properties were used to run finite element analyses (FEBio). The simulations compared the von Mises stress given a 20 N point load across both bandage material and bandage geometry.

FABRICATION

Market-available bandages were purchased and cut using a Cricut Maker 3 (Cricut, Inc., South Jordan, UT, USA). The clips were printed using Formlabs Elastic Resin in a Formlabs 2 SLA 3D printer (Formlabs, Somerville, MA, USA). Different versions of the clips were printed with varying inside diameters beginning at 0.300 cm and incrementally increasing by 0.025 cm with the largest diameter being 0.400 cm (**Figure 1**). Four clips of each diameter size were printed and tested.

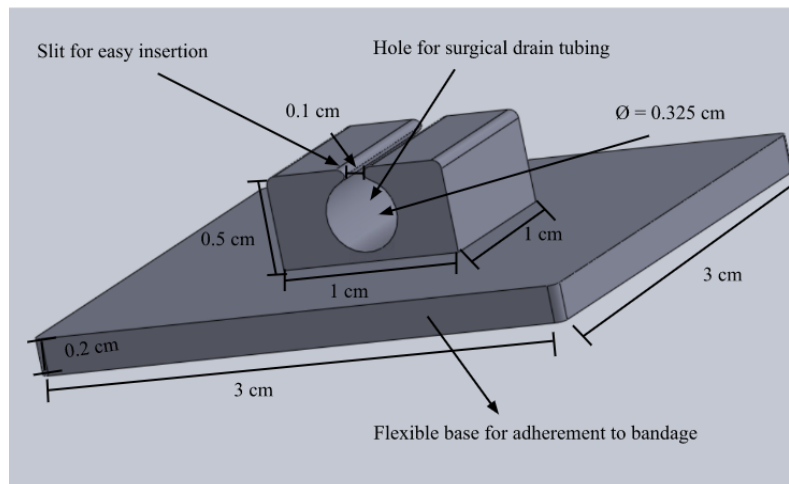

Figure 1: Clip design highlighting important features and dimensions.

After the clips were printed, the top of the clip was traced on the waterproof adhesive, and the tracing was cut out before it was used to adhere the clip to the hydrocolloid. The clip was placed one centimeter away from the edge of the precut hydrocolloid bandages on the opposite edge of the slit. Ensuring the cutout was lined up with the clip, the waterproof adhesive was first adhered in the center of the hydrocolloid below the clip and then adhered to the edge of the clip and the rest of the hydrocolloid bandage (**Figure 2**). The edge of the bandage was traced using a razor blade, as well as the exit hole and slit, to remove the excess waterproof adhesive from the device.

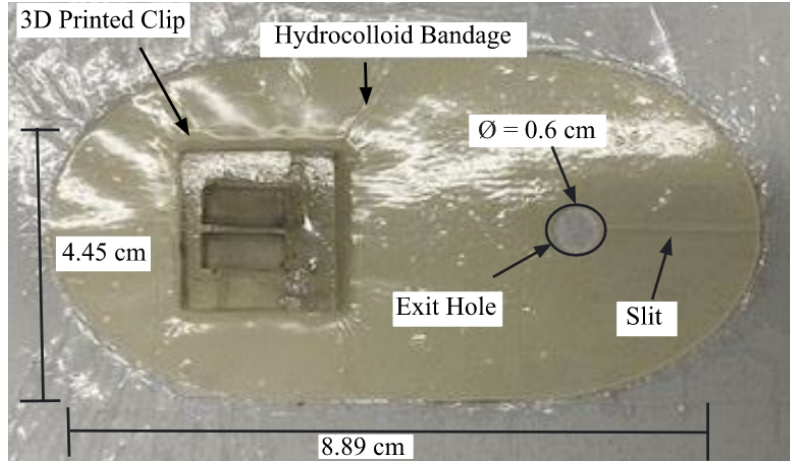

Figure 2: Final prototype highlighting important features and dimensions.

The first cohort of bandages created for testing were fabricated in a manner where the waterproof adhesive was applied first to the area around the clip base edges and a straight edge tool was used to secure the adhesive and remove any air bubbles on the rest of the bandage. A slit was then cut through the adhesive to expose the top face of the clip. The second cohort of bandages for testing were fabricated in a similar manner except a precut hole was created for the size of the clip and the waterproof adhesive was applied in the center of the bandage below where the clip was placed. The adhesive was then adhered over the edges of the clip and the rest of the hydrocolloid bandage.

SUPPORT STRENGTH TESTING

To determine which clip diameter can hold the most weight without displacement from the original position, the clips were adhered to a flat, vertical surface and the surgical drain tubing (Jackson-Pratt™ Silicone Flat Drain with a 100 mL Reservoir, CardinalHealth™, Waukegan, IL, USA) was secured in the clip. Water was pipetted into the drainage bulb and attached centrifuge tubes in 10 mL increments until the tubing slipped or there was obvious displacement. Grip-Lok® (TIDI Products, Neenah, WI, USA) was also tested utilizing this same method as a comparison to a product on the market.

FLOW TESTING

A flow test was done to ensure that the clip does not compress or block the surgical drain. Both water and a corn syrup-water mixture, to mimic the viscosity of blood, were tested. The corn syrup mixture was made by mixing 3 parts of light corn syrup (Essential Everyday®, Unfi Providence, Rhode Island, USA) and 1 part of water. Food coloring (3-4 drops) was also added to help visualize the fluid flow. Testing was

done by attaching one end of drain tubing to a vacuum pump (GAST® Manufacturing, Fair Plain, Michigan, USA) with a vacuum pressure of 86 kPa in the SterilGard® III Advance (The Baker Company, Sanford, Maine, USA) to mimic the vacuum that occurs when the drain is in the body. The amount of time it took to vacuum 30 mL of water through the tube while it was placed in the clip was recorded. To standardize this data, the flow velocity was calculated by dividing the distance the fluid traveled by the time it took to vacuum the water through the tube. This process was repeated using 20 mL of the corn syrup mixture to mimic the behavior of blood.

BANDAGE WEAR TESTING

A simulation wear test was conducted to compare the fabricated device to an on-the-market device, Grip-Lok®. Each device was placed side-by-side on a sheet of tattoo skin (Rayyl, Zhejiang, China), to mimic human skin. Four samples in two cohorts were tested consistently for two weeks. A 0.01% salt solution was sprayed onto the samples in the afternoon to mimic sweating conditions, and water was poured onto the samples at night to mimic showering conditions. After each test, the skin mimic was bent five times along both the short and long edges. A rating of how well the devices adhered to the skin mimic was done after each sweat and water test as well (**Table 1**). This scale was created to assess how well the device adhered to tattoo skin.

Table 1: Bandage Wear Rating	
1	Bandage has completely fallen off.
2	Obvious signs of wear and peeling on the bandage. Decreased functionality.
3	Moderate signs of wear and peeling on the bandage. Edge of the bandage begins to lift.
4	Small signs of wear and peeling on the bandage.
5	No signs of wear or peeling on the bandage. Bandage looks like it was just placed.

STATISTICAL ANALYSIS

MATLAB was used to perform statistical analyses. Analysis of Variance (ANOVA) was used with a significance level of 0.05 to determine significant differences for all testing. If significance was found, then a multiple comparisons test was performed using Tukey's honestly significant difference.

Results

BANDAGE SELECTION

The maximum effective stress per bandage material as calculated by FEBio is shown in **Figure 3**. An ANOVA test was done to determine if there was a significant difference between at least two of the bandage types ($p=0.0114$, $F=6.64$, $df=2$), and multiple comparisons of means revealed a significant difference between the elastic therapeutic tape and waterproofed elastic therapeutic tape ($p=0.0105$). The hydrocolloid bandage was not significantly different from the elastic therapeutic tape ($p=0.5815$) nor the waterproofed elastic therapeutic tape ($p=0.0643$).

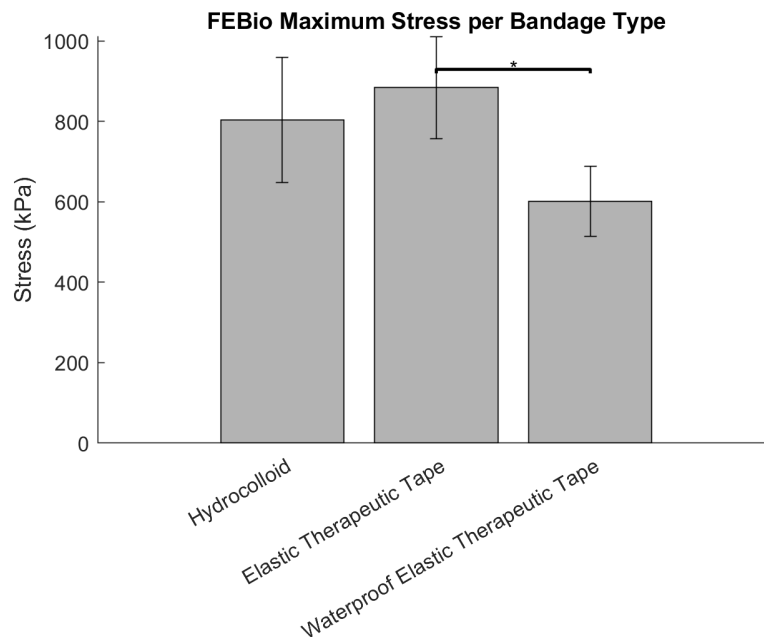

Figure 3: The average maximum effective stress per bandage material as calculated by FEBio given a 20 N point load. A significant difference existed between at least two of the bandage types ($p=0.0114$, $F=6.64$, $df=2$), and multiple comparisons of means revealed a significant difference between the elastic therapeutic tape and waterproofed elastic therapeutic tape ($p=0.0105$). The hydrocolloid bandage was not significantly different from the elastic therapeutic tape ($p=0.5815$) nor the waterproofed elastic therapeutic tape ($p=0.0643$).

The maximum effective stress per bandage geometry as calculated by FEBio is shown in **Figure 4**. ANOVA showed no significant difference between any of the bandage geometries ($p=0.8224$, $F=0.37$, $df=4$).

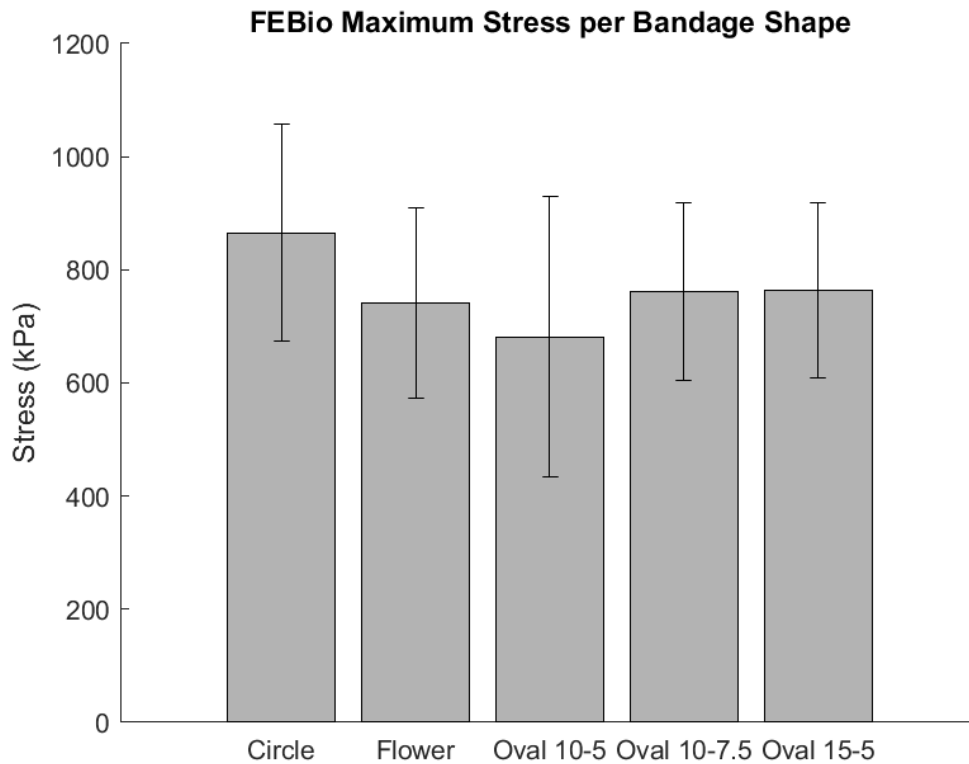

Figure 4: The maximum effective stress per bandage geometry as calculated by FEBio. Oval geometries are given as a ratio of the major axis to the minor axis. No significant difference existed between any of the bandage geometries ($p=0.8224$, $F=0.37$, $df=4$).

SUPPORT STRENGTH TESTING

The average mass supported per attachment method is shown in **Figure 5**. ANOVA revealed a significant difference between at least two of the attachment methods ($p<0.001$, $F=14.92$, $df=5$). Multiple comparisons of means showed the 0.300 cm clip was significantly different than the 0.325 cm clip ($p=0.0095$), the 0.350 cm clip ($p<0.001$), the 0.375 mm clip ($p=0.0019$), the 0.400 cm clip ($p<0.001$), and Grip-Lok® ($p=0.0065$). The 0.400 cm clip was also significantly different from the 0.325 cm clip ($p=0.0043$) and Grip-Lok® ($p=0.0212$).

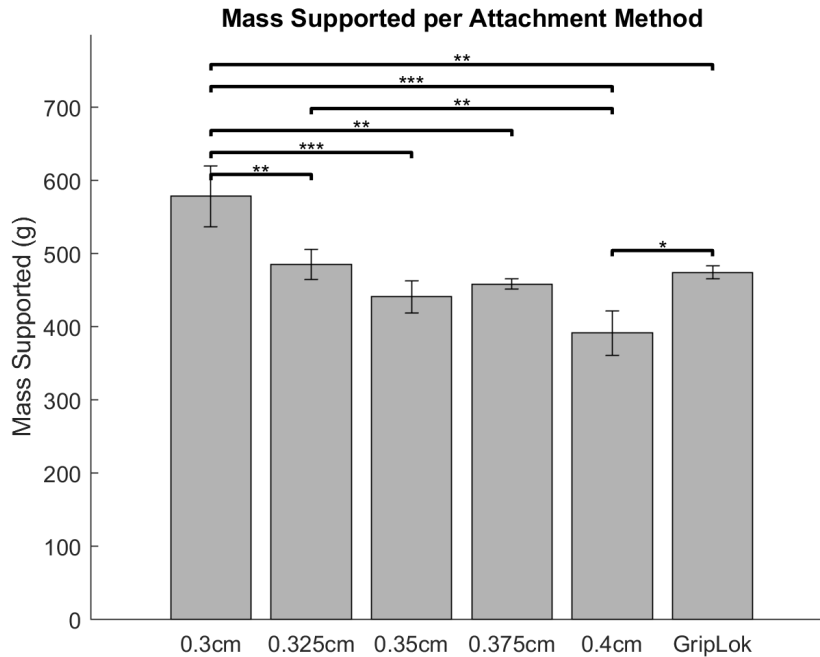

Figure 5: The average mass supported per attachment method. A significant difference exists between the 0.300 cm clip and the 0.325 cm clip ($p=0.0095$), the 0.350 cm clip ($p<0.001$), the 0.375 cm clip ($p=0.0019$), the 0.400 cm clip ($p<0.001$), and Grip-Lok® ($p=0.0065$). The 0.400 cm clip was also significantly different from the 0.325 cm clip ($p=0.0043$) and Grip-Lok® ($p=0.0212$).

FLOW TESTING

The average flow velocity of water and the corn syrup-water mixture through clips with varying interior diameters is shown in **Figure 6**. ANOVA showed no significant difference when water flowed through the drain ($p=0.9502$, $F=0.18$, $df=4$), but a significant difference existed between at least two of the groups when the corn syrup-water mixture flowed through the drain ($p<0.001$, $F=28.25$, $df=4$). Multiple comparisons of means revealed the 0.300 cm clip had a significantly different flow velocity than the 0.325 cm clip ($p<0.001$), the 0.350 cm clip ($p<0.001$), the 0.375 cm clip ($p<0.001$), and the control (no clip) ($p<0.001$).

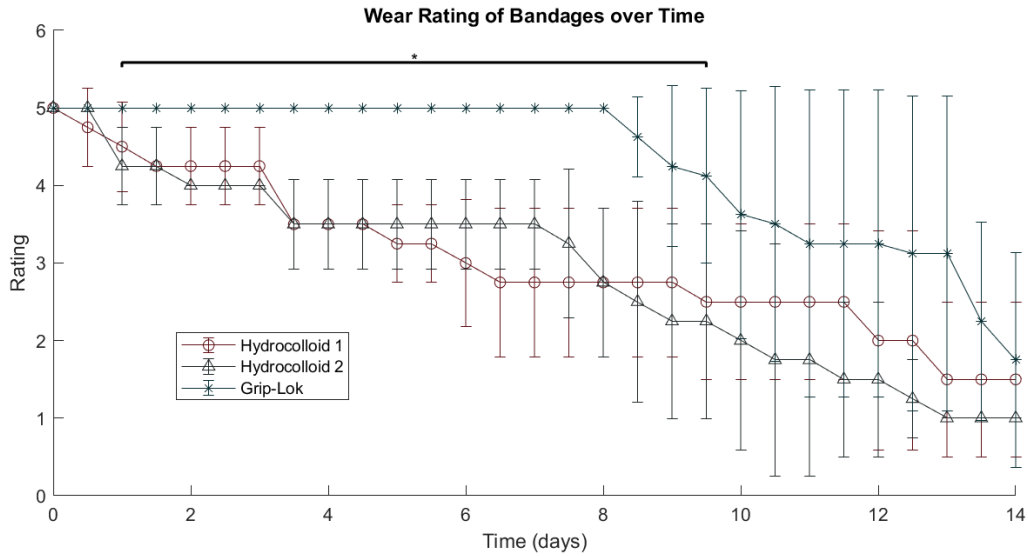

Figure 7: The wear rating of bandages over time. A significant difference existed between days 1-9.5 ($p=0.0124, 0.0026, <0.001, <0.001, <0.001, <0.001, <0.001, <0.001, <0.001, <0.001, <0.001, <0.001, 0.0017, 0.0183, 0.0269$), with Grip-Lok® being different than Hydrocolloid 2 at days 1 ($p=0.0138$), 9 ($p=0.0240$), and 9.5 ($p=0.0443$). Grip-Lok® also differed significantly from both Hydrocolloid 1 and 2 from days 1.5-8.5 ($p=0.0084, 0.0084; p<0.001, <0.001; p<0.001, <0.001; p<0.001, <0.001; p<0.001, <0.001; p<0.001, <0.001; p<0.001, <0.001; p<0.001, <0.001; p<0.001, <0.001; p<0.001, <0.001; p<0.001, =0.0014; p<0.001, =0.0014; p<0.001, =0.0020; p<0.001, <0.001; p=0.0091, 0.0038$).

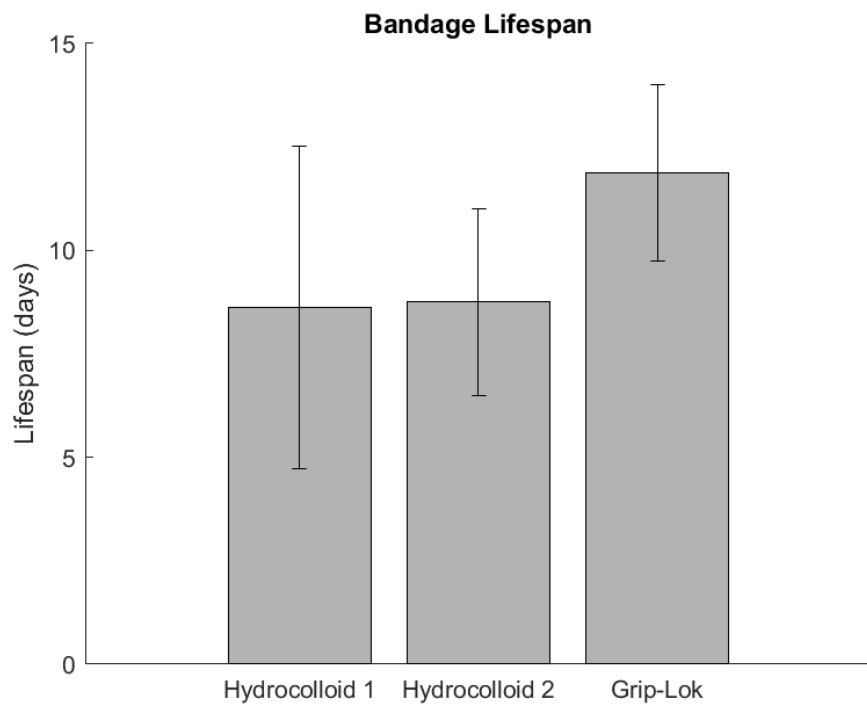

Figure 8: The average lifespan for Grip-Lok® and both hydrocolloid cohorts. ANOVA showed no significant difference between any of the bandages ($p=0.0942, F=2.85, df=2$).

Discussion/Conclusion

The final iteration of the device consists of a hydrocolloid bandage with the 3D printed clip adhered via the waterproof adhesive. The final clip diameter to secure the drain tubing was 0.325 cm as determined through strength and flow testing. ANOVA simulations showed that there were no significant differences in stress distribution based on bandage shape; therefore, an oval-shaped base was chosen, creating a greater distance between the clip and drain site while limiting surface area. This also allows for convenient positioning based on user preference. The addition of a waterproof adhesive layer was added to provide additional protection to the site and secure the clip to the hydrocolloid bandage. Modified testing protocols were made to accommodate the time constraints of human participation. Wear testing was used to simulate clinical use, attempting to identify how the device deteriorates over time compared to a market device (Grip-Lok®). While this provided some insight, the testing methods may not have provided the best simulation. First, the skin mimic was silicone based, and could not provide all the intricacies of natural skin. Next, the functionality of the attachment method was not tested. So while testing showed underwhelming results for the device when compared to Grip-Lok®, these may not be indicative of overall device performance. It is hypothesized that the Grip-Lok attachment to the drain will quickly deteriorate due to being an adhesive, while the clip on the device will remain functional much longer. Future testing methods would involve assessing attachment function over time, as well as wear duration, effectiveness, and comfort of the design when used clinically. In order to secure the clip to the bandage more effectively and efficiently, an exploration surrounding the use of medical-grade cyanoacrylate will be conducted. Methods for proper sterilization and packaging techniques, as well as shelf life, must be determined.

Acknowledgment

The team thanks Dr. Tracy Puccinelli for her advice and guidance throughout the entirety of the project.

Statement of Ethics

No animals or humans were involved in the testing conducted. All testing models were fabricated, and there are no ethical concerns to declare at this time.

Conflict of Interest Statement

The authors have no conflicts of interest to declare.

Funding Sources

Materials were funded by the Department of Biomedical Engineering at the University of Wisconsin - Madison.

Data Availability

The data that support the findings of this study are available on request from the corresponding author T. Puccinelli. The data are not publicly available due to the protection of intellectual property by the University of Wisconsin-Madison.

References

1. Mastectomy and Double Mastectomy - Brigham and Women's Hospital [Internet]. [cited 2023 Feb 27]. Available from: <https://www.brighamandwomens.org/surgery/surgical-oncology/resources/mastectomy>
2. Marion L. Everything You Need to Know About Surgical Drains - Chicago Plastic Surgery [Internet]. Plastic Surgery of Chicago. 2020 [cited 2022 Oct 10]. Available from: <https://www.plasticsurgeryofchicago.com/surgical-drains/>
3. Seroma: What Is It, Causes, Treatment, and More | Osmosis [Internet]. [cited 2022 Oct 10]. Available from: <https://www.osmosis.org/answers/seroma>
4. Agrawal A, Ayantunde AA, Cheung KL. Concepts of Seroma Formation and Prevention in Breast Cancer Surgery. *ANZ J Surg.* 2006;76(12):1088–95.
5. Janis JE, Khansa L, Khansa I. Strategies for Postoperative Seroma Prevention: A Systematic Review. *Plast Reconstr Surg.* 2016 Jul 1;138(1):240–52.
6. Tiwari A, McFarlane JP, Peters JL. A simple technique for securing surgical drains. *Injury Extra.* 2022 Nov;35(11):91–3.
7. O'flynn P, Akhtar S. Effective securing of a drain. *Ann R Coll Surg Engl.* 1999 Nov;81(6):418–9.
8. Heskin L, Cahill V, Filobos G, Regan P, O'Sullivan S, Bryan K. A new adaptation for a secure surgical drain placement and a comparison with four common drain fixation methods. *The Annals of The Royal College of Surgeons of England.* 2019 Jan;101(1):60–8.
9. Epomedicine. Techniques of Securing Surgical Drain to Skin (Drain Fixation) [Internet]. Epomedicine. 2021 [cited 2022 Oct 10]. Available from: <https://epomedicine.com/surgical-skills/techniques-securing-surgical-drain-fixation/>
10. Ringel Y, Haberfeld O, Kremer R, Kroll E, Steinberg R, Lehavi A. Intercostal chest drain fixation strength: comparison of techniques and sutures. *BMJ Military Health.* 2020 Oct;167(4).
11. Yousefpour A, Gibbons AJ, Whear NM. A simple way of securing suction drains: Technical note. *British Journal of Oral and Maxillofacial Surgery.* 2006 Apr;44(2):161–2.
12. Disposable Drainage Tube Holder - Changzhou Haiers Medical Devices Co., Ltd. [Internet]. Hasmedicalstapler.com. 2018 [cited 2022 Oct 10]. Available from: https://www.hasmedicalstapler.com/Disposable_Drainage_Tube_Holder
13. Tube Attachment Devices | Critical Care Products | Hollister US [Internet]. www.hollister.com. 2022 [cited 2022 Oct 10]. Available from: <https://www.hollister.com/en/products/Critical-Care-Products/Tube-Securement/Tube-Attachment-Devices#>
14. Li WY. Dr. Li's Guide to Getting Drains After Surgery [Internet]. *Surgical Secrets.* 2022 [cited 2022 Oct 10]. Available from: <https://surgicalsecrets.com/blogs/articles/guide-to-getting-drains-after-surgery>
15. Campbell J. How To Take Care of Your Drains After Breast Surgery [Internet]. *Verywell Health.* 2021 [cited 2022 Oct 10]. Available from: <https://www.verywellhealth.com/managing-your-surgical-drains-following-breast-surgery-4021630>

Appendix A

Product Design Specifications

Improved Method of Securing Surgical Drains

Team: Dana Stumpfoll, Rebekah Makonnen, Lauren Heller, Oscar Zarneke, Abdoulahi Bah

Client: Dr. Kathryn Kalscheur

Advisor: Dr. Tracy Jane Puccinelli

Date: February 10, 2023

Function:

Surgical drains are used to keep certain fluids and air from accumulating in a dead space that is created during surgery [1]. These are attached to patients using sutures which are stitches that attach and hold the tube in the patient's skin [1]. However, these sutures cause pain and discomfort due to tension at the suturing site [2][3]. The created device will address this problem by reducing the amount of tension produced at the suturing site. This problem will be addressed by developing a device that improves the attachment of the surgical drains to the skin. As a result, the patient will have a more comfortable experience with decreased irritation while the surgical drain is in place.

Client requirements:

- The device will need to work effectively in various environments including normal physiological conditions as well as exposure to water.
- The device should be able to work for any type of surgical drain and be placed in any location.
- The device should maintain function and provide comfort when the patient is performing various movements and daily activities including walking, sleeping, stretching, and exercising.
- The drainage wound site should be accessible for sanitizing using alcohol or various soaps.

Design requirements:

1. Physical and Operational Characteristics

a. *Performance requirements:*

The device should be replaceable and removable for sanitary reasons until the surgical drain collects less than 25 - 30 cc of fluid, which can take 1 to 5 weeks [2][4]. Once the drainage amount is consistently below 25 - 30 cc of fluid, the drain can be removed. The device should also prevent displacement of the surgical drain tube, especially during patient movement or when pulled on. In addition, the device should relieve the tension created at the attachment site of the surgical drain tube. It will also be necessary that the device is biocompatible with the skin to avoid irritation when in use. Lastly, the device will need to follow certain FDA protocols highlighted in section 3a.

b. Safety:

This attachment device should not cause any additional irritation or inflammation to the patient. It should not inhibit drainage flow or cause the tube to be displaced. The site should also be able to be cleaned to ensure that it is sanitary and will not cause any infections.

c. Accuracy and Reliability:

The attachment device should be able to hold the surgical drain in place without irritating the patient's skin. This device should not allow for displacement greater than 3.16 +/- 1.0 mm [5]. It should also be adjustable to ensure it is adequately secured and for patient comfort.

d. Life in Service:

This product should be able to last for the duration that the surgical drain is attached to the patient, up to one week. This device should be able to withstand all of the activities that accompany a normal life without any impact on its function or how secure it is.

e. Shelf Life:

While not in use, this device will be stored in a standard healthcare storage closet at room temperature. If properly stored, the attachment device should be able to be kept for 36 to 40 months [6].

f. Operating Environment:

The attachment device will be placed near the exit site of a surgical drain and will have to maintain its function while exposed to body temperatures, cleansing and showering, and stripping of the drain to ensure the drain does not become clogged. The design will likely be attached to the patient's skin and should be able to maintain its function at body temperatures ranging from 98.3 +/- 4.0°F [7]. This range

accounts for the temperatures the patient's body might get to if they are instructed to do light exercises while the drains are still in place. Patients are instructed to shower while their surgical drains are in place so the design should not lose its integrity when exposed to water [8]. Drains also need to be regularly stripped to ensure they remain functional, so the design should not detach or displace during this process [2].

g. Ergonomics:

The design should not detach from the patient's skin after accidental tugging or movement [2]. The housing design should allow the patient to move around and attend their daily activities without interruption. The housing design will incorporate a way to easily hide or wrap this extra tubing. The patient should also be able to access their drain site for the duration they need the drain which can range from 1 to 5 weeks [9].

h. Size:

Most surgical drain diameters range from 0.25 inches to 1 inch and are 14-18 inches long [4][10]. The attachment device will be able to accommodate this range of diameters.

i. Weight:

The design should weigh less than 1 oz as this competes with current devices on the market and will not cause increased discomfort on the patient's skin [11].

j. Materials:

The design must use sterile materials that do not interfere with natural wound healing. The materials should not evoke an immune response at the drainage site. Water-soluble materials cannot be used, as the site must be washed frequently [12]. The material should not notably expand or contract. The design must also use durable materials to withstand use for up to several weeks but must be easy to remove in as little as a few days [13]. Drains are used for varying durations of time, and the design must be versatile to represent this.

k. Aesthetics, Appearance, and Finish:

The final design must have a smooth finish to avoid any unnecessary catching on clothing [2]. In addition to this, it should conceal the appearance of the drains. Ideally, the design will have various skin tone

options for a more discreet appearance [14]. The design should also be able to be used in conjunction with an existing method of securing tubing and drainage bulbs so that the design accounts for all portions of the drainage process, not just at the drain-skin contact point [15].

2. Production Characteristics

a. *Quantity:*

Only one or two units will be needed to show proof of concept. The design should be easily scalable to large quantities to match the rapidly growing need for surgical drains [16].

b. *Target Product Cost:*

Various other products on the market typically fall in the range of \$25 to \$35 [14]. Our design should fall within this range, however, it will ideally be lower in cost than similar products on the market. If scaled up to match market demand, the price will ultimately be lower than the initial cost of production.

3. Miscellaneous

a. *Standards and Specifications:*

The FDA classifies surgical sutures [17], topical adhesives [18], and surgical drains [19] as class II medical devices. Therefore, new attachment methods must follow the FDA's general and special controls. All equipment must be sterilized following FDA sterilization guidelines [20].

b. *Customer:*

The device should prevent tugging on the drain, a source of pain and discomfort for the patient. Additionally, it should be concealed under normal clothing or be designed to appeal to all customers.

c. *Patient-related concerns:*

New attachment methods must be sterilizable prior to use and must allow visual access to the insertion site. The housing device should be machine washable and avoid kinking the drain tube.

d. *Competition:*

Many variations of surgical drain bulb holders have been patented including:

- Medical drainage pouch [21]

- Post-surgical drainage bulb support sling [22]
- Post-surgical drainage container carrier [23]
- Drain tube belt and shower pack kit [24]
- Surgical recovery brassiere [25]
- Drainage reservoir support assembly [26]
- Surgical drainage device [27]
- Abdominal binder with improved drainage bulb holding system [28]
- Apparatus and method for carrying and storing medical drains [29]
- Drain pouch caddy [30]
- Post-operative compression bra and drain apron [31]
- Surgical drain management apparatus [32]
- Drain tube holder system [33]
- Ostomy pouch holding system [34]
- Surgical drainage reservoir support [35]
- Medical drain carrier [36]
- ** This is a non-exhaustive list **

Methods for surgical drain attachment include:

- Sutures with Tie-Lok [37]
- Adhesive device [38]
- Prolene suture with beads [39]
- Centurion sandal [5]
- Centurion sandal with two locking plastic ties [5]
- Centurion sandal with Steristrips [5]
- Double loop sutures [5]
- Multiple loop sutures [5]
- Classical suture loop and knot [40]
- Roman Gaiter suture technique [40]
- Locking-Turns suture technique [40]
- ** This is a non-exhaustive list **

References:

- [1] R. Durai and P. C. H. Ng, "Surgical vacuum drains: types, uses, and complications," *AORN J.*, vol. 91, no. 2, pp. 266–71; quiz 272–4, 2010.
- [2] D. W.-Y. Li, "Dr. Li's guide to getting drains after surgery," *Surgical Secrets*, 07-Oct-2020. Available:
<https://surgicalsecrets.com/blogs/articles/guide-to-getting-drains-after-surgery>.
- [3] L. U. M. Corion, M. J. C. Smeulders, P. P. M. van Zuijlen, and C. M. A. M. van der Horst, "Draining after breast reduction: a randomised controlled inter-patient study," *J. Plast. Reconstr. Aesthet. Surg.*, vol. 62, no. 7, pp. 865–868, 2009.
- [4] M. S. Jean Campbell, "How to take care of your drains after breast surgery," *Verywell Health*, 05-Apr-2016. Available:
<https://www.verywellhealth.com/managing-your-surgical-drains-following-breast-surgery-4021630>.
- [5] L. Heskin, V. Cahill, G. Filobos, P. Regan, S. O'Sullivan, and K. Bryan, "A new adaptation for a secure surgical drain placement and a comparison with four common drain fixation methods," *The Annals of The Royal College of Surgeons of England*, vol. 101, no. 1, pp. 60–68, Jan. 2019, doi: 10.1308/rcsann.2018.0177.
- [6] J. James, "Do Bandages Expire?," *Survivalfreedom.com*, 17-Oct-2019.
- [7] "Fever: First aid," *Mayo Clinic*, 11-Jun-2022. [Online]. Available:
<https://www.mayoclinic.org/first-aid/first-aid-fever/basics/art-20056685>.
- [8] "Care of your surgical drain at home," *Uwhealth.org*. Available:
<https://patient.uwhealth.org/healthfacts/4603>.
- [9] "After surgical procedure instructions for JP drain and surgical incision," *Ucdavis.edu*. Available:
https://health.ucdavis.edu/surgery/specialties/oncologic/jp_instructions.pdf.
- [10] J. Easley and J. Schumacher, "Basic equine orthodontics and maxillofacial surgery," in *Equine Dentistry*, Elsevier, 2011, pp. 289–317.

- [11] "Vertical tube attachment device (VTAD)," Hollister.com. [Online]. Available: https://www.hollister.com/en/products/critical-care-products/tube-securement/tube-attachment-devices/vertical-tube-attachment-device-_vtad_.
- [12] "Patients & families: UW health," Health and Nutrition Facts for You | Patients & Families | UW Health. Available: <https://patient.uwhealth.org/healthfacts/4603>.
- [13] B. J. C. L. W. R. M. T. C; "How long should suction drains stay in after breast surgery with axillary dissection?," Annals of the Royal College of Surgeons of England. Available: <https://pubmed.ncbi.nlm.nih.gov/9422871/>.
- [14] "Seecret Apron™ - post-surgical Drain Holder & Pouch," Surgical Seecrets. [Online]. Available: <https://surgicalsecrets.com/products/seecret-apron>.
- [15] "PATFT." [Online]. Available: <https://patft.uspto.gov/>.
- [16] "Surgical drains market statistics, Growth Drivers: Forecast- 2030," Allied Market Research.[Online]. Available: <https://www.alliedmarketresearch.com/wound-drainage-surgical-drains-market-A07517>.
- [17] Center for Devices and Radiological Health, Surgical Sutures - Class II Special Controls Guidance Document for Industry and FDA Staff. Food and Drug Administration, 2003.
- [18] Center for Devices and Radiological Health, Tissue Adhesive for the Topical Approximation of Skin - Class II Special Controls Guidance for Industry and FDA Staff. Food and Drug Administration, 2008.
- [19] Center for Devices and Radiological Health, "Wound Drain Catheter System FDA Classification, Life Cycle Events [5825]," Food and Drug Administration. <https://fda.report/Product-Code/deviceId/5825> (accessed Oct. 10, 2022).
- [20] Center for Devices and Radiological Health, "Sterilization for Medical Devices," Food and Drug Administration, Jun. 06, 2022. <https://www.fda.gov/medical-devices/general-hospital-devices-and-supplies/sterilization-medical-devices>
- [21] G. C. Persichetti and F. W. Piraino, "Medical drainage pouch," Oct. 23, 2012
- [22] D. Bachelder, "Post-surgical drainage bulb support sling," Apr. 19, 2011

- [23] N. F. Turner, "Post-surgical drainage container carrier," Jul. 01, 1997
- [24] P. L. Watson and V. M. Watson, "Drain tube belt and shower pack kit," Nov. 28, 2000
- [25] D. A. Brooks, "Surgical recovery brassiere," May 21, 2002
- [26] M. Hadley-Fruit, "Drainage reservoir support assembly," Feb. 25, 2003
- [27] M. R. Prody and Dale Medical Inc, "Surgical drainage device," Aug. 26, 2003
- [28] A. Frazer and Dale Medical Products Inc, "Abdominal binder with improved drainage bulb holding system," Nov. 29, 2011
- [29] M. Barnes and Hudson Holder Inc, "Apparatus and Method for Carrying and Storing Medical Drains," Apr. 19, 2012
- [30] S. S. Wellborn and J. E. Hildreth, "Drain pouch caddy," Jun. 11, 2015
- [31] L. M. Blackwell, "Post-operative compression bra and drain apron," Dec. 23, 2015
- [32] J. Baker and M. Baker, "Surgical drain management apparatus," Jan. 04, 2018
- [33] L. R. Fee, P. Fee, and Red Oak Innovations LLC, "Drain tube holder system," Feb. 19, 2019
- [34] S. Blatt, "Ostomy pouch holding system," Jun. 15, 2021
- [35] M. A. R. Prody, "Surgical drainage reservoir support," Aug. 17, 2021
- [36] C. J. Dolphin, "Medical drain carrier," Dec. 14, 2021
- [37] A. Tiwari, J. P. McFarlane, and J. L. Peters, "A simple technique for securing surgical drains," *Injury Extra*, vol. 35, no. 11, pp. 91–93, Nov. 2004, doi: 10.1016/j.injury.2004.07.025.
- [38] A. Yousefpour, A. J. Gibbons, and N. M. Whear, "A simple way of securing suction drains: Technical note," *British Journal of Oral and Maxillofacial Surgery*, vol. 44, no. 2, pp. 161–162, Apr. 2006, doi: 10.1016/j.bjoms.2004.10.019.
- [39] P. O'flynn and S. Akhtar, "Effective securing of a drain," *Ann R Coll Surg Engl*, vol. 81, no. 6, pp. 418–419, Nov. 1999, doi: PMID: 10655897; PMCID: PMC2503306.

[40] Epomedicine, “Techniques of Securing Surgical Drain to Skin (Drain Fixation)”, Epomedicine, Jun. 10, 2021. <https://epomedicine.com/surgical-skills/techniques-securing-surgical-drain-fixation/>

Appendix B

DESIGN PROCESS

One method the team brainstormed to improve the fixation of surgical drains was a clip design that would be attached to an adhesive bandage. This adhesive bandage with a clip design would be used alongside the suture placed by the surgeon to hold the drain in place. The adhesive would be made from a hydrocolloid bandage, as they are designed to be worn for up to a week (1). The hydrocolloid bandage consists of an outer layer that would act as a barrier to protect the wound from bacterial contamination and foreign particles (1). The hydrocolloid adhesive layer would be used to absorb moisture from the wound and create a hydrogel that promotes healing (1). This bandage would be placed over the wound site and would encourage proper wound healing.

The clip design would be made from high-density polyethylene since this material absorbs little water and is typically used as a plastic material for most medical devices (1). The clip would be attached to a platform made from high-density polyethylene to allow for easy attachment to the adhesive portion of the design. This preliminary design can be seen in **Figure 1**.

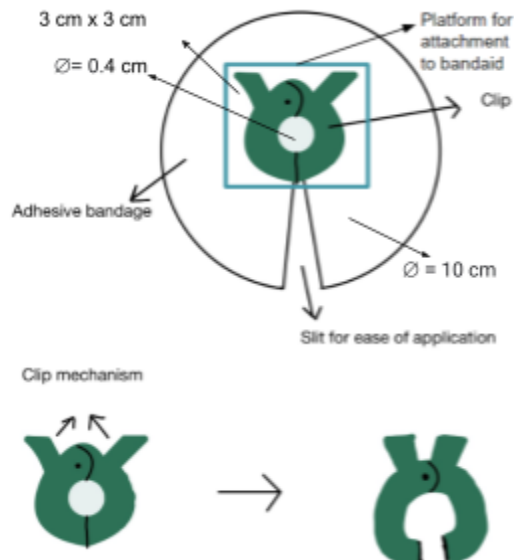

Figure 1: Drawing of the adhesive bandage with clip design placed at the drainage site. The clip would wrap around the surgical drain tubing exiting the patient's skin.

Another method the team brainstormed for securing the surgical drain would be to replace the use of sutures with another device. This device would consist of a rigid tube that would be made from high-density polyethylene to fit the diameter of the surgical drain tubing. The high-density polyethylene was chosen since it is a rigid plastic that is biocompatible (2). The flaps would be made from silicone since silicone is a flexible material that is also biocompatible (3).

This device would be placed around the tubing of the surgical drain and implanted when the surgeon places the surgical drain. The flaps would be pulled up and flattened to allow them to be placed into the wound site as seen in **Figure 2**. Once the device is placed under the skin, the rigid tube would be pulled up to allow the silicone flaps to flatten out underneath the skin as seen in **Figure 3**. Each flap would be used to distribute the pressure under the skin in different spots. A locking tie or clip would be wrapped along the edge of the tube outside the body to prevent the tube from getting pushed back further into the patient's body, and to prevent the displacement of the device. This device would remain in place for the entire duration the surgical drains would need to be in place. This device is not adjustable as it would be slid on once the drain is in place and multiple sizes would need to be created to accommodate different drain sizes.

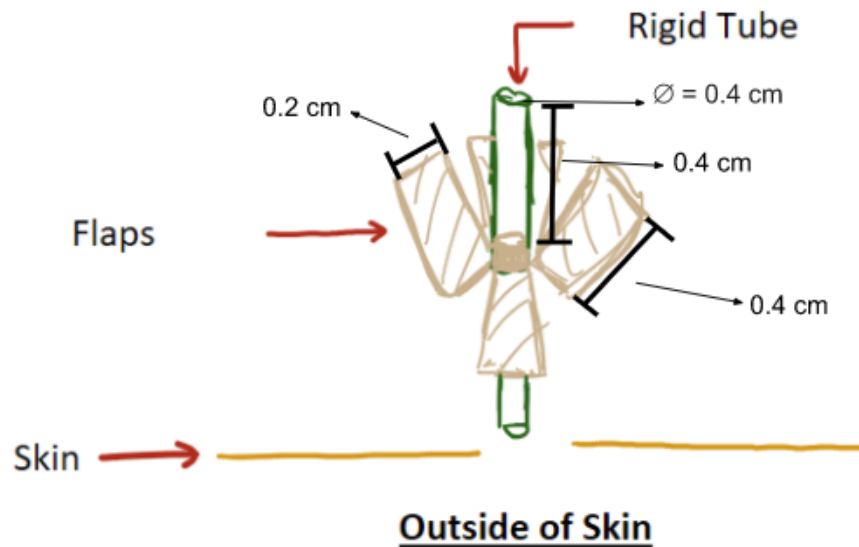

Figure 2: The silicone flaps in their upright position against the rigid tube for insertion at the wound site.

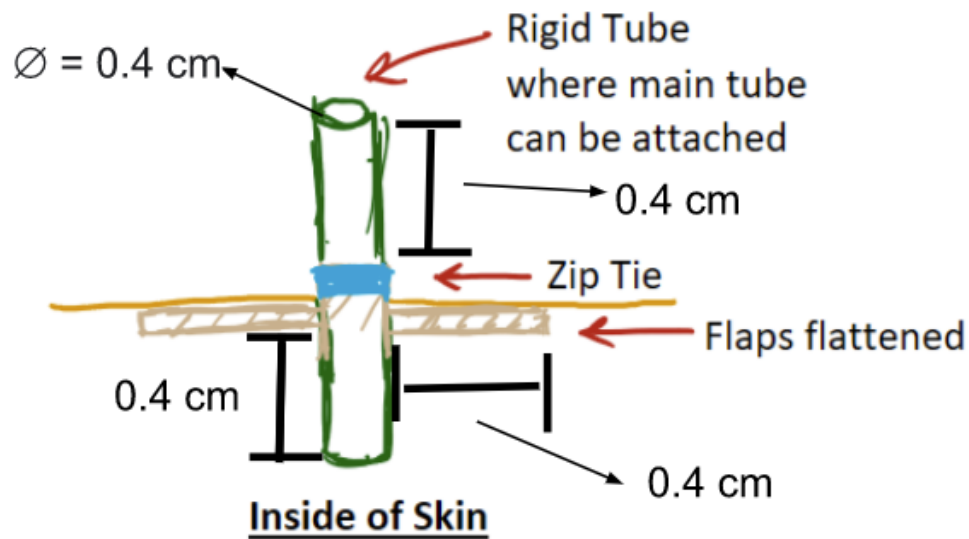

Figure 3: The silicone flaps are flattened underneath the skin with a tie around the rigid tube to hold the device in place outside the patient's skin.

The third design would be used alongside the sutures that the surgeon typically uses to hold the drain in place. This design consists of pressure-distributing flaps made from a material similar to elastic therapeutic tape. Elastic therapeutic tape is made from a cotton-woven base that allows for a more breathable bandage (4). Elastic therapeutic tape is very porous allowing for moisture to seep through the bandage, preventing the degradation of the adhesive material (4). This would allow for the elastic therapeutic tape to remain in place for up to a week at a time. This is ideal for this project as this will reduce the cost of the device and allow for the patient to continue to do daily activities such as showering and physical therapy exercises that may be assigned by their doctor without having to constantly replace the tape. Each flap would distribute the pressure evenly on the patient's skin away from the suture site.

The silicone ring of the design would be used to hold the drain securely in place. Silicone was chosen for this as it is very flexible and will not compress the surgical tube enough to stop the flow of fluid out of the drain (5). The gauze padding would be placed on the underside of the adhesive where the wound site and suture site are as can be seen in **Figure 4**. This ensures that the wound site and suture are not being tugged on by the adhesive material.

This design would be beneficial in distributing the pressure evenly on the patient's skin. The elastic therapeutic tape material is not waterproof and this means the patient would have to replace it when showering or when it begins to fall off. This would increase the cost of this design.

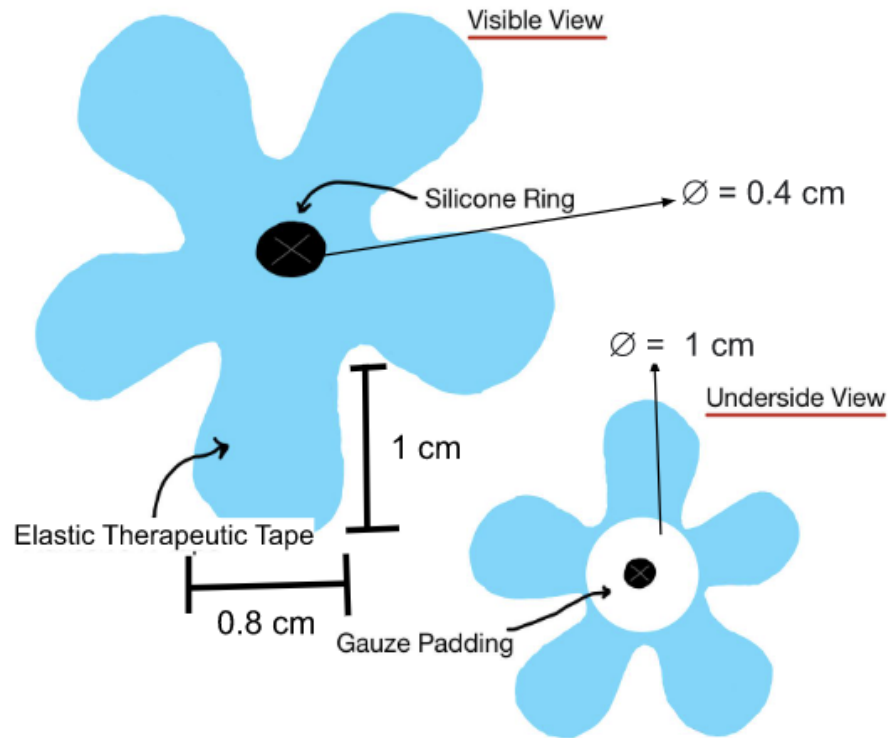

Figure 4: The pressure-distributing adhesive flaps with a top and bottom view.

To evaluate the three designs that were brainstormed the team created a design matrix (**Figure 5**). The criteria for the designs were ranked in importance based on the client's needs. Effectiveness was ranked the highest because the design needs to be able to hold the surgical drain tubes in place and prevent any displacement from occurring. Patient comfort was ranked next, as this is emphasized by the client as a problem with the current method of attaching surgical drains to a patient. This criterion is scored on how comfortable the design will be once it is installed on the patient. Additionally, it was rated on how well the design will ideally be able to alleviate the pain that occurs at the wound site. Ease of use was described as how easily the design can be installed and the amount of maintenance required once it is installed. The cost was then used to assess the necessary expenses to fabricate and maintain the design. Lastly, adaptability was used to analyze how well the design can be used in various locations on the patient's body.

		 Adhesive Bandage with Clip		 Interior Pressure Distributing Flap		 Exterior Pressure Distributing Flap	
Criteria	Weight	Score (10 max)	Weighted Score	Score (10 max)	Weighted Score	Score (10 max)	Weighted Score
Effectiveness	30	8	24	6	18	8	24
Patient Comfort	25	8	20	3	8	9	23
Ease of Use	20	7	14	9	18	6	12
Cost	15	8	12	9	14	6	9
Adaptability	10	10	10	7	7	8	8
Sum	100	Sum	80	Sum	66	Sum	76

Figure 5: The preliminary design matrix.

Based on the criteria in the design matrix, the adhesive bandage with clip design and pressure-distributing flaps outside scored highest for effectiveness. This is because the two designs would still implement sutures to attach surgical drains (6). Both designs would increase the stability and support of the surgical drains at the wound site. For patient comfort, the pressure-distributing flaps scored the highest due to its use of elastic therapeutic tape which would help with comfort and disperse the pressure when surgical tubes were tugged on. The second design scored low because some components would be under the skin, which could cause pain if the tubes were tugged on. In addition, inflammation could occur due to foreign body reactions of the silicone flaps going under the skin (7). As for ease of use, the second design scored the highest since it does not require sutures to attach the tubes and requires little maintenance once it is installed. This is different from the first and second designs because these designs require the need for sutures and adhesives which would need to be changed daily. This reasoning is also applied to the cost criterion resulting in the second design scoring the highest. Lastly, for the adaptability criterion, the first design scored the highest. This is because this design uses a clip mechanism that is adjustable for the use of different-diameter drains.

After analyzing each design using the criteria generated above the adhesive bandage with clip design was chosen as the final design. This design was chosen because of its ability to provide added support

for the surgical drain tubes at the wound site and prevent their displacement. In addition to the added support, this design can relocate the tension that occurs at the suture site to lessen the discomfort that the patient experiences.

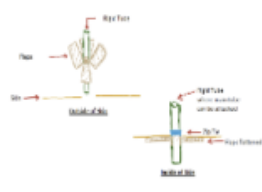
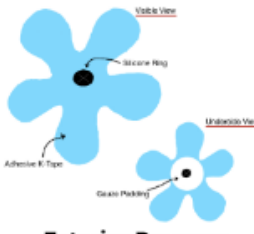
Once the final design was decided upon, the team began fabricating and testing. To begin the fabrication process, the team obtained a set of large hydrocolloid bandage sheets. After testing various geometries in FEBio, it was determined that the geometry of the bandage does not have a significant effect on force distribution. The team decided to proceed with an oval shape to allow for a greater distance between the clip and drain site.

Methods to fabricate the correct shape of the hydrocolloid bandage involved the use of a Cricut Maker 3. The use of the Cricut machine allowed precise and uniform cuts of the bandage. The bandage shape, drain tube opening, and slit for easy application were all created using this fabrication method. The proposed clip design (**Figure 6**) was rendered in Solidworks and printed in the UW Makerspace using a Formlabs Form 2 SLA printer. The clip was printed with an elastic resin, allowing for a structured clip with moderate flexibility to accommodate different tubing diameters.

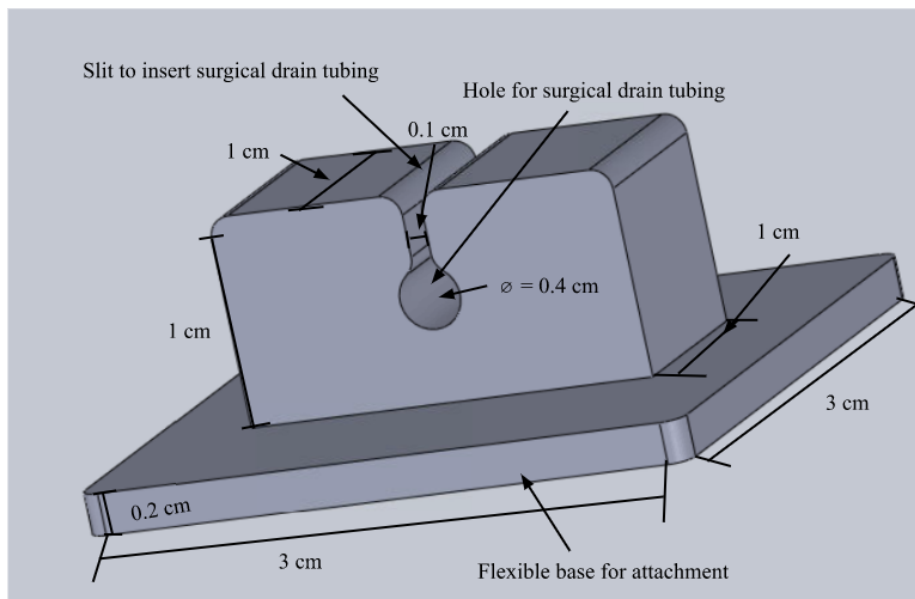

Figure 6: Clip design with dimensions.

The complete bandage assembly process involved the attachment of the clip to the bandage. For prototyping and testing, the clip was adhered to the bandage using a generic cyanoacrylate adhesive.

The use of a non-medical grade adhesive was used to create a prototype for proof of concept rather than for medical-grade patient use (**Figure 7**).

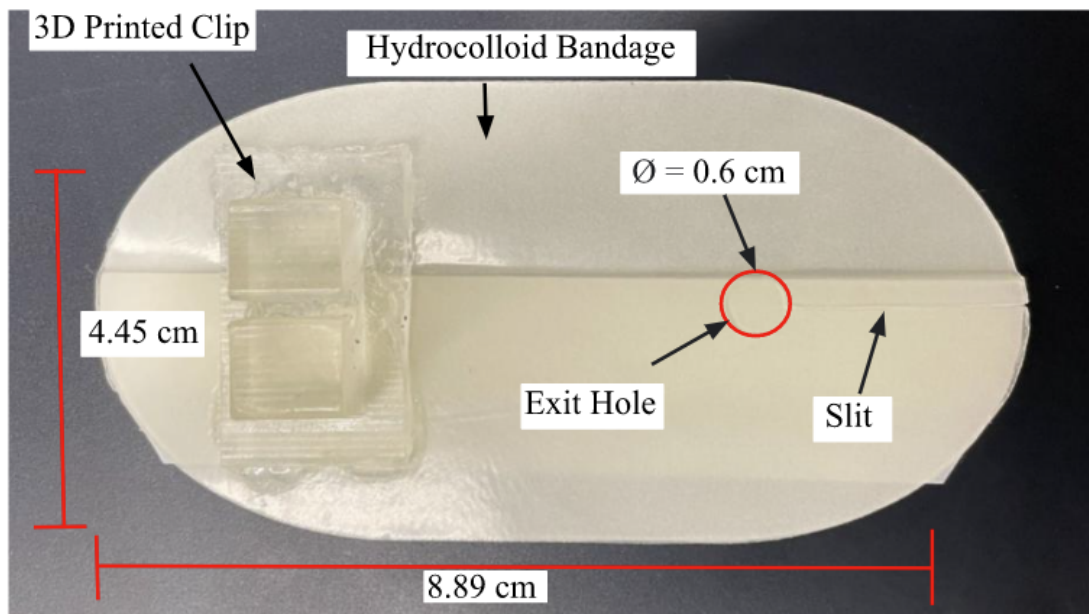

Figure 7: Top view of the first prototype with highlighted features and dimensions.

After re-evaluating the prototype, the team decided to reconsider the method of adhering the clip to the bandage. The team has contacted employees at 3M and Mölnlycke for ideas for creating a double-layer adhesive to secure the clip to the hydrocolloid bandage. The team has also created new clip iterations that consist of 4 different diameters (0.300 cm, 0.325 cm, 0.350 cm, 0.375 cm, and 0.400 cm). The new clip design is less bulky compared to the previous design as the dimensions around the insertion point for the surgical drain tubing have been reduced. To determine which clip would secure the surgical drain tubing without impinging on the flow of the fluid through the tubing, strength testing has been performed (**Figure 8**) on all the new clip iterations as well as flow testing utilizing water and a corn syrup-water mixture to mimic the viscosity of blood (**Figure 9**). From this testing, it was determined that the 0.300 cm diameter clip could hold the most amount of weight, but it did obstruct the flow through the tubing when the corn syrup was flushed through the tubing, to mimic blood flowing out of the wound. The next clip that held the most amount of weight and did not impinge on the surgical drain was the clip with a 0.325 cm diameter. This clip was chosen for the final design.

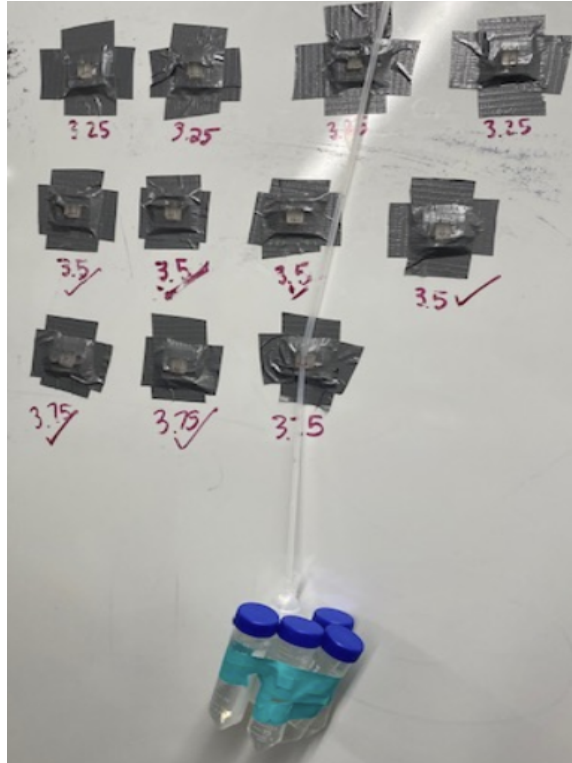

Figure 8: Support strength testing setup for testing each clip diameter size.

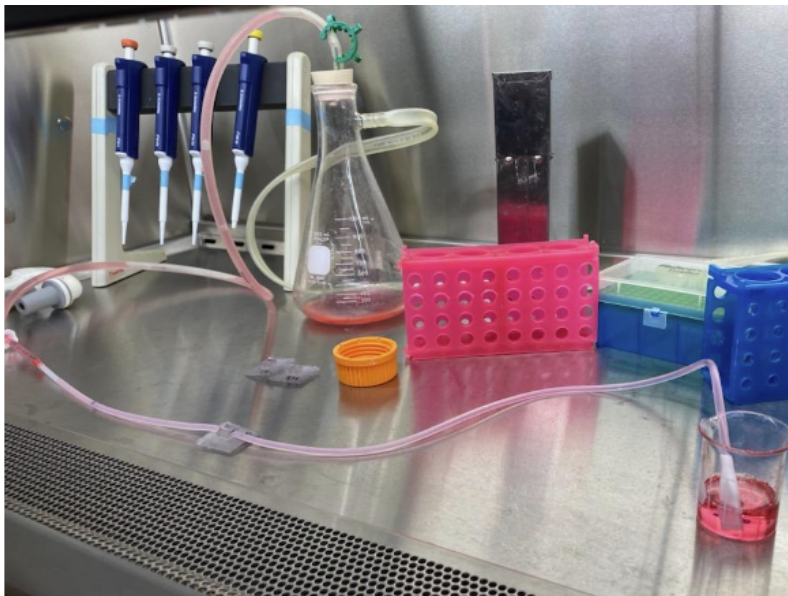

Figure 9: Experimental setup for flow testing. The vacuum pump in the biosafety cabinet was used to create a consistent flow through the surgical drain tubing.

Once the final clip design was chosen, models were created for mimicking sweat and water testing since the IRB did not approve human testing for this project. This testing consisted of adhering Grip-Lok® and the final prototype next to each other on a single sheet of tattoo skin that mimics the properties of real skin (**Figure 10**). Four sheets were tested consistently for two weeks, where a sweat test was conducted in the afternoon and a water test was performed at night. After each test, the sheets were bent 5 times in the longitudinal and lateral directions along the edge of the tattoo skin sheets. Ratings were taken after each sweat and water test to determine how well the bandages were still adhered. The rating scale was created using a scale from 1-5, where 1 meant the bandage would no longer be functional, and 5 meant there were no signs of wear or peeling on the bandage (**Table 1**). From this, it was determined that the Grip-Lok® held up better in terms of adherence to the tattoo skin.

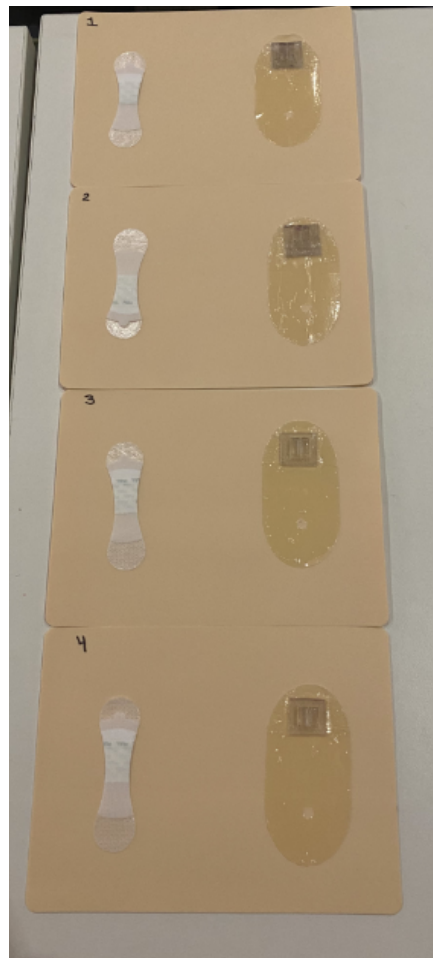

Figure 10: Experimental setup for wear testing.

Table 1: Bandage Wear Rating	
1	Bandage has completely fallen off.
2	Obvious signs of wear and peeling on the bandage. Decreased functionality.
3	Moderate signs of wear and peeling on the bandage. Edge of the bandage begins to lift.
4	Small signs of wear and peeling on the bandage.
5	No signs of wear or peeling on the bandage. Bandage looks like it was just placed.

Once the wear testing was completed, the final prototype was constructed. The top of the clip was traced on the waterproof adhesive and the tracing was cut out before it was used to adhere the clip to the hydrocolloid. The final prototype consists of a 0.325 cm diameter clip (**Figure 11**) which was placed one centimeter away from the edge of the precut hydrocolloid bandages on the opposite edge of the slit. Ensuring the cutout was lined up with the clip, the waterproof adhesive was first adhered in the center of the hydrocolloid below the clip and then adhered to the edge of the clip and the rest of the hydrocolloid bandage (**Figure 12**). The edge of the bandage was traced using a razor blade, as well as the exit hole and slit, to remove the excess waterproof adhesive from the device.

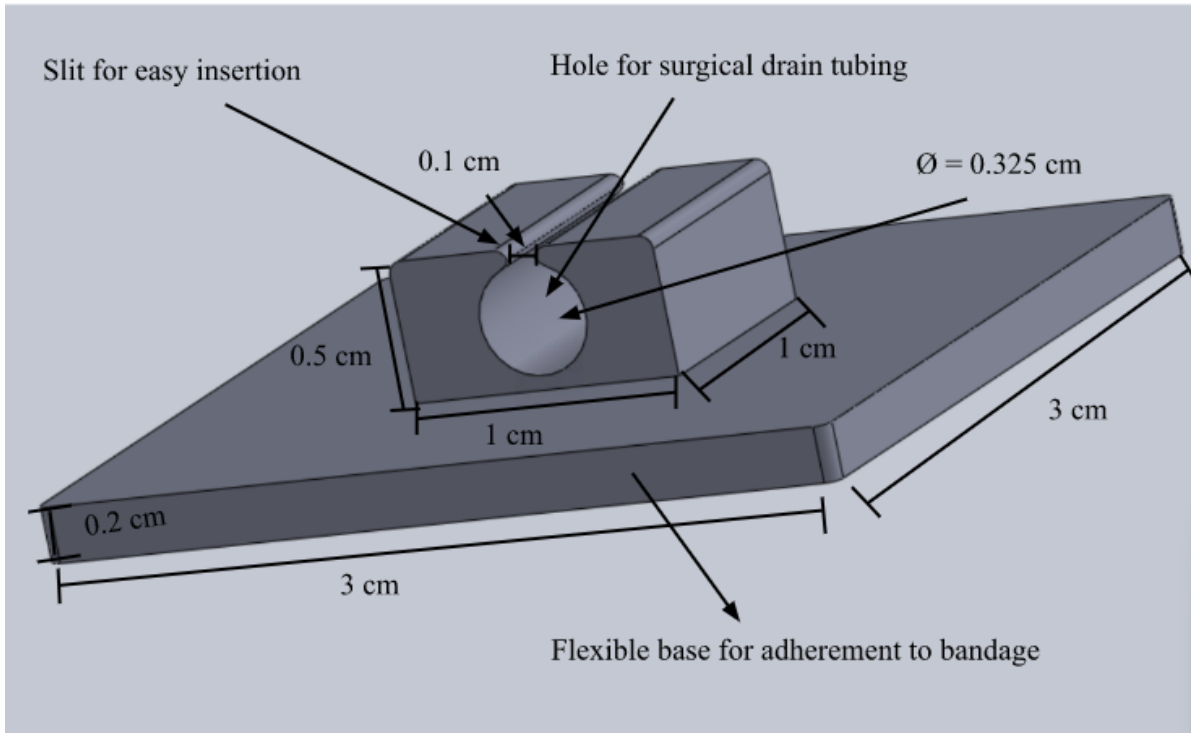

Figure 11: Most recent iteration of the clip design with 0.400 cm diameter. The clip is less bulky to reduce the probability of tugging on clothing and has a more flexible base.

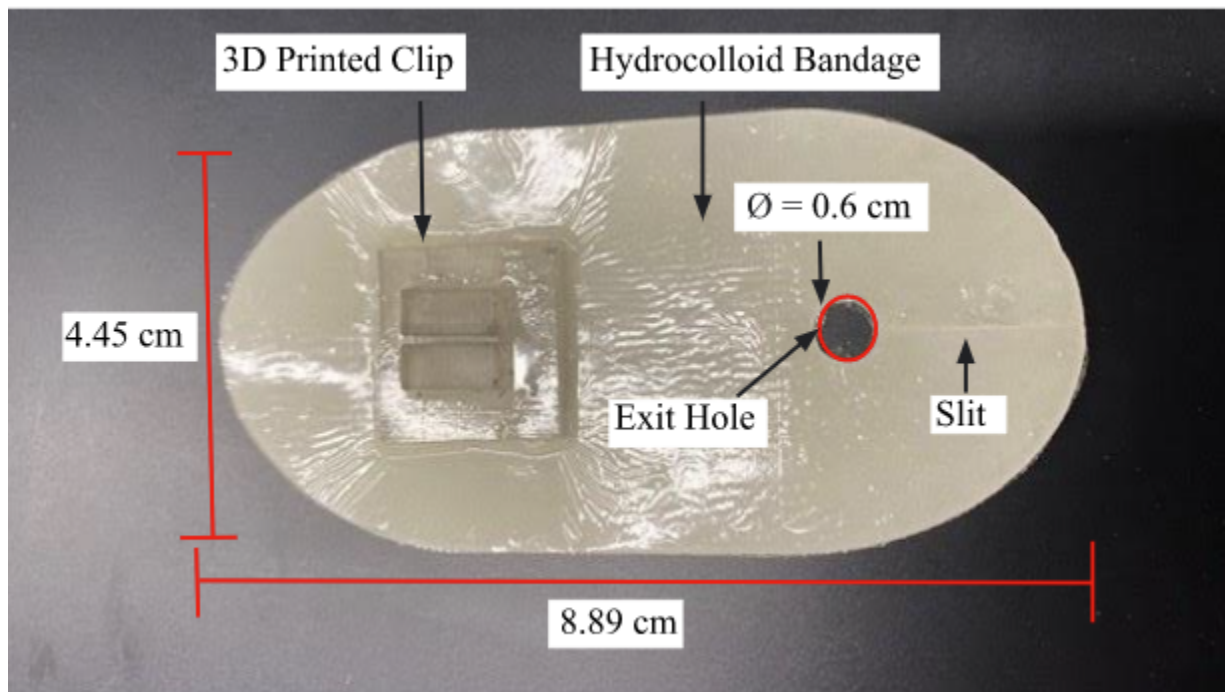

Figure 12: Final prototype with highlighted features and dimensions.

References

1. Barnes HR. Wound care: fact and fiction about hydrocolloid dressings. *J Gerontol Nurs.* 1993 Jun;19(6):23–6.
2. Dewing J. Medical Devices Equipment: What Plastic Materials Are Used in Them? [Internet]. *Proto Plastics.* 2022 [cited 2022 Oct 10]. Available from: <https://protoplastics.com/plastic-materials-medical-devices-equipment/>
3. França DCC, de Castro AL, Soubhia AMP, de Aguiar SMHCÁ, Goiato MC. Evaluation of the Biocompatibility of Silicone Gel Implants – Histomorphometric Study. *Acta Inform Medica.* 2013;21(2):93–7.
4. Tunakova V, Tunak M, Mullerova J, Kolinova M, Bittner V. Material, structure, chosen mechanical and comfort properties of kinesiology tape. *J Text Inst.* 2017 Dec 2;108(12):2132–46.
5. Zare M, Ghomi ER, Venkatraman PD, Ramakrishna S. Silicone-based biomaterials for biomedical applications: Antimicrobial strategies and 3D printing technologies. *J Appl Polym Sci.* 2021;138(38):50969.
6. Tiwari A, McFarlane JP, Peters JL. A simple technique for securing surgical drains. *Injury Extra.* 2022 Nov;35(11):91–3.
7. Carnicer-Lombarte A, Chen ST, Malliaras GG, Barone DG. Foreign Body Reaction to Implanted Biomaterials and Its Impact in Nerve Neuroprosthetics. *Front Bioeng Biotechnol* [Internet]. 2021 [cited 2022 Oct 10];9. Available from: <https://www.frontiersin.org/articles/10.3389/fbioe.2021.622524>

Appendix C

TESTING PROTOCOLS

1. MTS Testing for Tensile Properties and Elastic Modulus

Detailed Steps of Testing:

1. Set up the MTS machine for tensile testing.
 - a. Use 100N rubber tensile grips unless otherwise specified by the instructor.
2. Obtain the bandages for testing (elastic therapeutic tape, hydrocolloid bandage, silicone bandage, elastic therapeutic tape with waterproofing).
3. Cut each sample of each bandage type into a bone shape.
 - a. Bone shape size should be consistent between each material sample.
4. Load a bandage, testing in the direction of the fibers.
5. Perform a tensile test to failure.
6. Record the elastic modulus.
7. Repeat steps 3-5, loading the bandage with fibers in the perpendicular direction.
8. Repeat steps 3-6 using the next bandage.

2. Testing for Poisson's Ratio and Shear Modulus

Detailed Steps of Testing:

1. Draw or stamp a perfect square onto the bandage. Record its dimensions.
2. Stretch the bandage using a uniaxial load. Record the square's dimensions.
3. Repeat step 2 with the load applied in the perpendicular direction.
4. Calculate Poisson's ratio ($\frac{\text{lateral deformation}}{\text{longitudinal deformation}}$) in both directions.
5. Assume elastic modulus and Poisson's ratio is the same in either perpendicular direction.
6. Calculate the shear modulus in three directions ($E=2G(1+\nu)$).

3. FEBio Simulation

Detailed Steps of Testing:

1. Create different geometries of the bandage in SolidWorks. Export as .STEP files.
2. Open the model in FEBio.
3. Set the material (orthotropic elastic) and its properties (density, elastic modulus in three directions, shear modulus in three directions, and Poisson's ratio in three directions).
4. Set the boundary condition to be on the adhesive surface, constrained in all directions.
5. Set the load at the clip location as a pressure surface load. Set the scale (as stress).
6. Optimize the mesh to find the one that has the best performance with the fewest elements.
7. Analyze the stress distribution using the optimized mesh.
8. Repeat steps 2-7 using each geometry.
9. Compare the distributions and the maximum stresses in each geometry. Choose the geometry that minimizes the maximum stress.

4. Force Testing Protocol

Detailed Steps of Testing:

1. Gather eight hydrocolloid bandages, four with Grip-Lok® and four with the clip attached to them.
2. Gather uniform weights.
3. Adhere the bandage to a clean vertical surface with the hole with the slit facing up.
4. Secure the surgical drain tube to the bandage using either the Grip-Lok® or the clip.
5. Draw a line on the surgical drain tube relative to the top edge of the mechanism holding it in place.
6. Attach the weight to the surgical drain tubing using tape.
 - a. If no weights are available, fill the surgical bulb with 10 ml of water at a time by pipetting it into the opening of the bulb.
 - b. If additional weights are needed 50 ml centrifuge tubes can be taped onto the bulb and 10 ml can be added at a time.
7. Release the weight and allow it to hang freely.

8. Record the weight and displacement of the surgical drain.
 - a. Measure the displacement from the line on the tubing to the top edge of the mechanism holding the drain in place.
9. Repeat steps 3-8 using an increased amount of weight until failure (bandage falls, tube falls out of attachment device, or something tears/breaks) and record the weight of failure.
 - a. Determine the weight added by using the density conversion of water.
 - i. $1 \text{ g/ml} \times 10 \text{ ml} = 10 \text{ g}$ for every 10 ml added.
10. Repeat steps 3-9 using another bandage.

5. Mock Flow Testing- Tube Impingement and Drainage Capability

Artificial Fluid Creation:

1. 3 Parts Light Corn Syrup
2. 1 Part Tap Water
3. 3 Drops of Food Coloring (easier to visualize fluid flow)

Detailed Steps of Testing:

1. Measure 40mL of water into a small beaker.
2. Remove the bulb from the end of the surgical drain apparatus, place the drainage end in the beaker, and secure the open end to the vacuum pump in the biosafety cabinet.
3. Time duration needed to drain 30 mL of the beaker through the tube and into the vacuum.
4. Repeat steps 1-3 two more times to obtain three baseline readings.
5. Repeat steps 1-3 three times each for clips of 3mm, 3.25mm, 3.5mm, and 3.75mm diameters.
6. Repeat the same procedure with 30 mL of the artificial fluid.
7. Analyze obtained data for statistical significance.