

Microscope Cell Culture Incubator

Team: Katie Day, Maya Tanna, Sam Bardwell, Drew Hardwick, Bella Raykowski

Advisor: Dr. Amit Nimunkar

Client: Dr. John Puccinelli

Date: 02/10/2023



Figure 1: Cell Culture Plates [1]

Background Information

- **Client:** Dr. John Puccinelli; Associate Chair of the Undergraduate Program
- **Cell Cultures**
 - Lab method for the use of studying cell biology, replicating disease mechanisms, and investigating drug compounds [2]
 - Use both primary, transformed, and self-renewing cells
- **Incubators**
 - Replicate cells' natural conditions in order for optimal growth
 - Natural Cell Environment - 37°C, pH = 7.2-7.4, 95% humidity [3]
 - Cost: \$500-\$40,000 [4]
- **Live-Cell Imaging**
 - Allows researchers to continually view cell development
 - Need incubator on a microscope in order to keep cells alive for imaging

Figure 2: On-stage incubator [4]



Problem Statement

- ❖ **Purpose:** Develop a low cost cell culture incubation chamber that fits on a microscope stand (<310x300x45mm), does not interfere with the lens optics, and is capable of live cell imaging.
- ❖ Current commercially available systems
 - Sometimes result in evaporation from low volume cultures
 - Expensive, too large, Enclose the entire microscope
 - Previous BME 200/300 design projects
 - Portable Live-cell Imaging Box ~ \$400 materials
 - Elliot Scientific and OkoLabs Stage Top Incubators [4] ~ \$400-\$1,000



Figure 3: Cell Culture Procedure [5]

PDS Summary

Performance requirements:

- Compatible with an inverted microscope in both size and function
- Maintain an internal environment of 37°C, 5% CO₂, and 95-100% humidity

Safety:

- Biosafety Level 1 Standards [6]

Accuracy and Reliability:

- Temperature of 37°C ± 1°C, humidity of >95%, and CO₂ levels of 5% ± 1%
- Maintain internal environment for at least 1 week

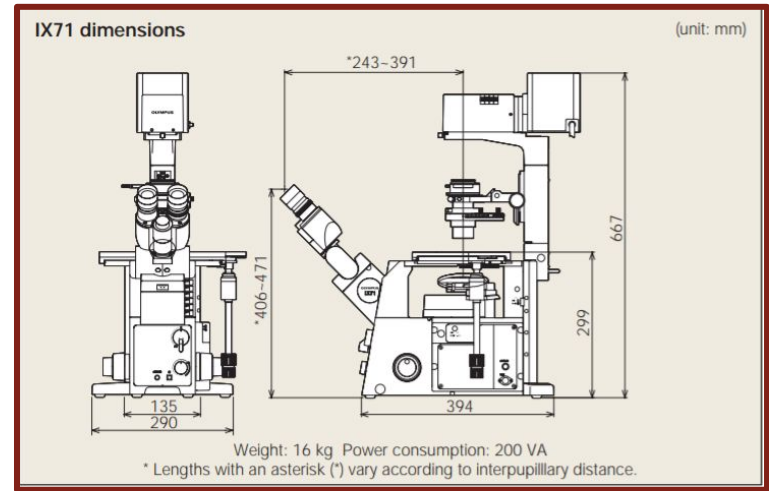

Figure 4: Measurements of Inverted Microscope [7]

PDS Summary cont.

Size:

- Incubator < 310x300 mm with a thickness < 45 mm

Materials:

- Transparent top and bottom surfaces

Target Production Cost:

- < \$100

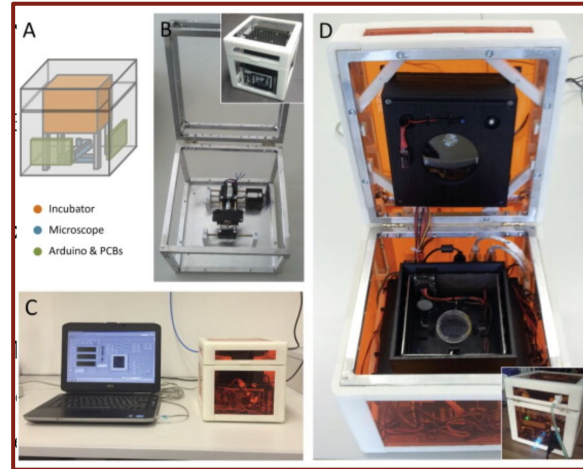

Figure 5: Portable Live-Cell Imaging Platform [8]

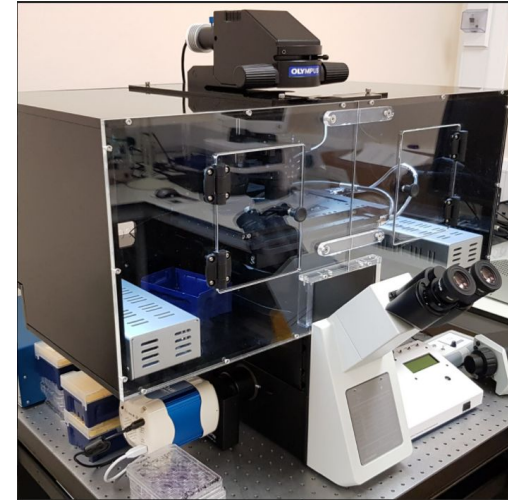

Figure 6: Elliot Scientific Stage Top Incubator [4]

Fall 2022 Work

Fabrication

- Laser cut black acrylic from UW-Makerspace
- Electronics
 - Thermistor = temp and humidity
 - MH-Z16 = CO₂
 - Solenoid valve and Relay circuit = CO₂ tank control
- Squeegee Wiper Blade for anti-fog

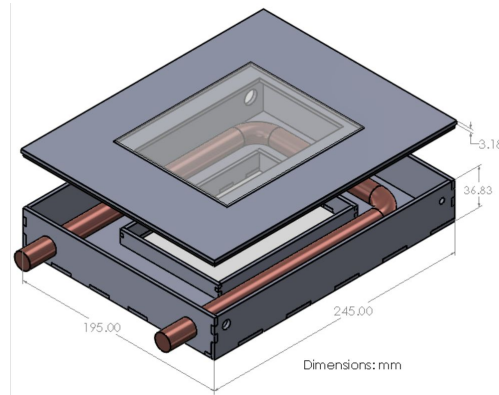

Figure 7: Final Prototype CAD drawing

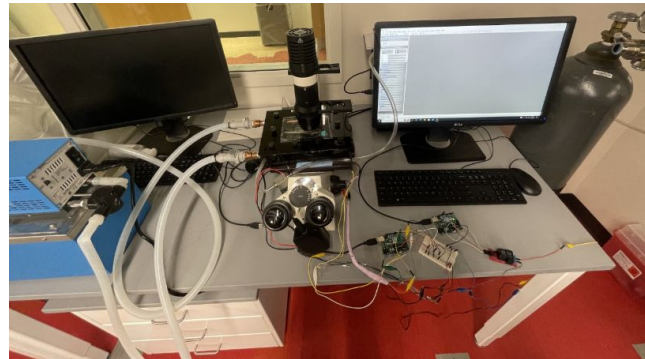

Figure 9: Final Prototype setup

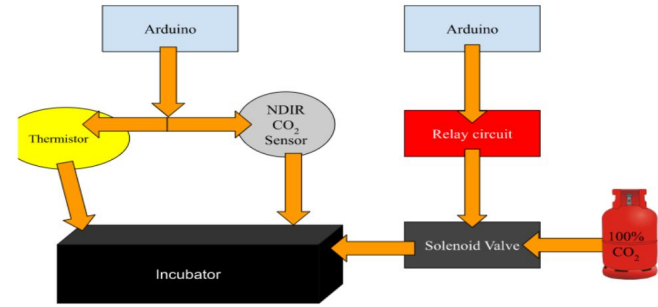

Figure 8: Flow chart of final design

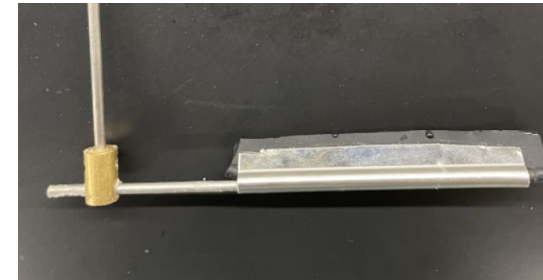

Figure 10: Wiper blade design

Fall 2022 Testing

Results

- Homogeneity testing was successful
- Optical testing was successful
- CO₂ hard-coded input failed along with CO₂ sensor

Conclusions

- Need to find a new CO₂ sensor
- Wiper blade must be better fabricated for anti-fogging methods
- More Live-Cell tests

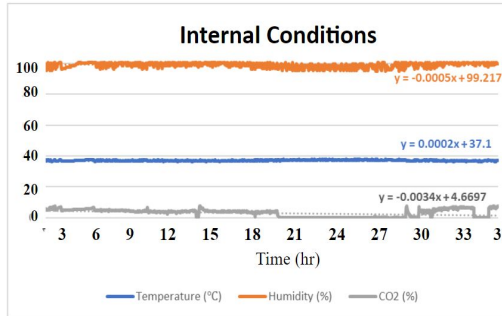

Figure 11: Internal Incubator Conditions Over Time

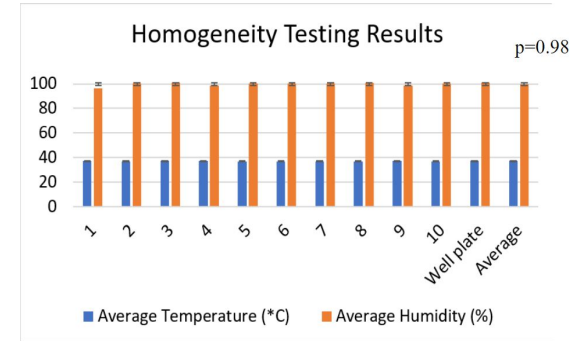

Figure 12: Homogeneity Testing Results

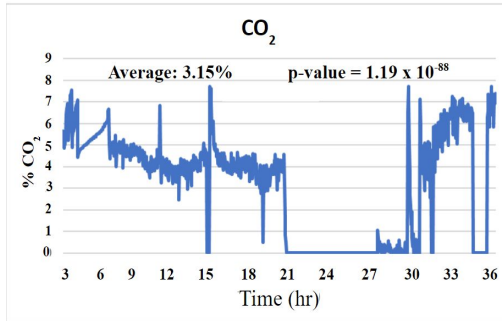

Figure 13: CO₂ Monitoring Over Time

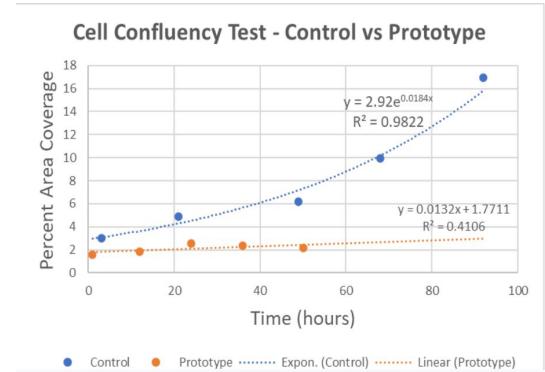

Figure 14: Cell Confluency Testing

CO₂ Sensors



Preliminary Design #1

MH-Z16 CO₂ Sensor

Strengths:

- Previous Use
- Compatibility with Arduino and Solenoid Valve
- Water resistant

Weaknesses:

- Costs
- Shorter Lifespan



Figure 15: MH-Z16 CO₂ Sensor [9]

Preliminary Design #2

BME 680

Strengths:

- Reads Temperature, humidity, and CO₂
- Arduino Compatible
- Low Cost

Weaknesses:

- Requires I2C
- Not waterproof
- Reads CO₂ in kOhm not ppm

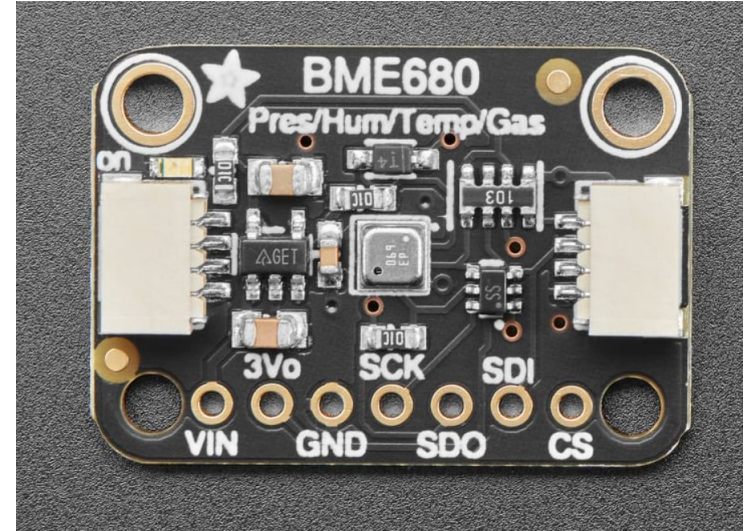

Figure 16: BME 680 Temperature, Humidity, and CO₂ Sensor [10]

Preliminary Design #3

MH-Z14A

Strengths:

- No I2C
- 10000 ppm
- Same company as current NDIR (design #1)

Weaknesses:

- Water droplet resistance
- May fail with high humidity



Figure 17: MH-Z14A CO₂ Sensor [11]

Design Matrix Criteria

- Performance - How well the sensor is able to read CO₂ in our environment?
- Water resistance - Will the sensor be able to withstand the water bath and condensation?
- Ease of use - ease of circuitry, ease of coding, ease of integration with existing electronics
- Cost - How expensive is the sensor?
- Life in service - How long will it be reliable?
- Safety - Will the sensor harm cells?

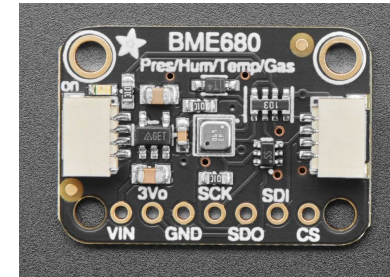

Figure 18: Images of Preliminary Designs #1-3 [9][10][11]

Design Matrix for CO₂ Sensor

			 MH-Z16		 BME 680		 MH-Z14A	
Rank	Criteria	Weight	Score (5 max)	Weighted Score	Score (5 max)	Weighted Score	Score (5 max)	Weighted Score
1	Performance	30	3	18	5	30	3	18
2	Water Resistance	20	5	20	0	0	4	16
3	Ease of use	20	5	20	1	4	2	8
4	Cost	15	1	3	5	15	3	9
5	Life in Service	10	3	6	3	6	5	10
6	Safety	5	5	5	4	4	5	5
Sum		100	Sum	72	Sum	59	Sum	66

Table 1: Design Matrix for CO₂ Sensor

Proposed Final Design



Figure 19: Proposed Final Design [9]

Anti-Fog/Condensation



Preliminary Design #1

ITO (Indium Tin Oxide) Coated Glass

Strengths:

- Excellent electrical conductivity and optical transparency
- Coating uniformity
- Pre-fabricated

Weaknesses:

- Expensive
- Difficult to purchase/acquire



Figure 20: ITO Conductive Glass [12]

Preliminary Design #2

Copper Grid Tape

Strengths:

- Easy to fabricate
- More surface area than copper wire

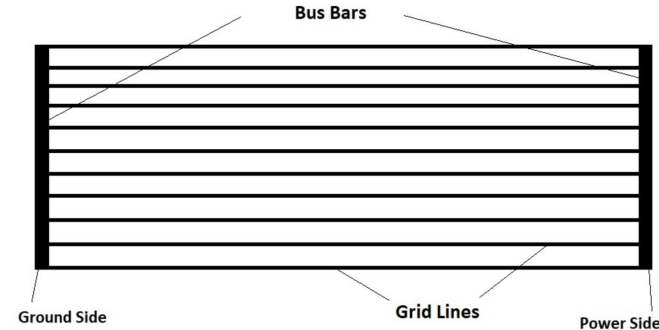

Figure 21: Copper tape for condensation prevention grid [13][14]

Weaknesses:

- Limited heating area
- Blocks optics in some areas
- Requires a lot of current

Preliminary Design #3

Micro Fan

Strengths:

- Easy to obtain
- Easy fabrication

Weaknesses:

- Not waterproof
- Hard to fit in the incubator box



Figure 22: Micro Fan for condensation prevention[15]

Design Matrix for Anti-Fog/Condensation Method



			 ITO Coating		 Copper Grid Tape		 Microfan	
Rank	Criteria	Weight	Score (5 max)	Weighted Score	Score (5 max)	Weighted Score	Score (5 max)	Weighted Score
1	Ease of Fabrication	25	3	15	4	20	5	25
2	Performance	25	5	25	3	15	4	20
3	Cost	20	1	4	4	16	5	20
4	Safety	15	5	15	4	12	4	12
5	Life in Service	15	5	15	3	9	2	6
Sum		100	Sum	74	Sum	72	Sum	83

Table 2: Design Matrix for Anti-Fog/Condensation

Proposed Final Design



Figure 23: Micro Fan for condensation prevention [15]

Current Work

- Box fabrication
- Condensation prevention design development
- Standard- Live cell testing

Future Work

- CO₂ Sensor coding
- CO₂ Sensor testing
- Condensation testing
- Prototype- Live cell testing



Figure 24: Top view of the new incubator box showing the caulking and copper piping

Upcoming Project Goals

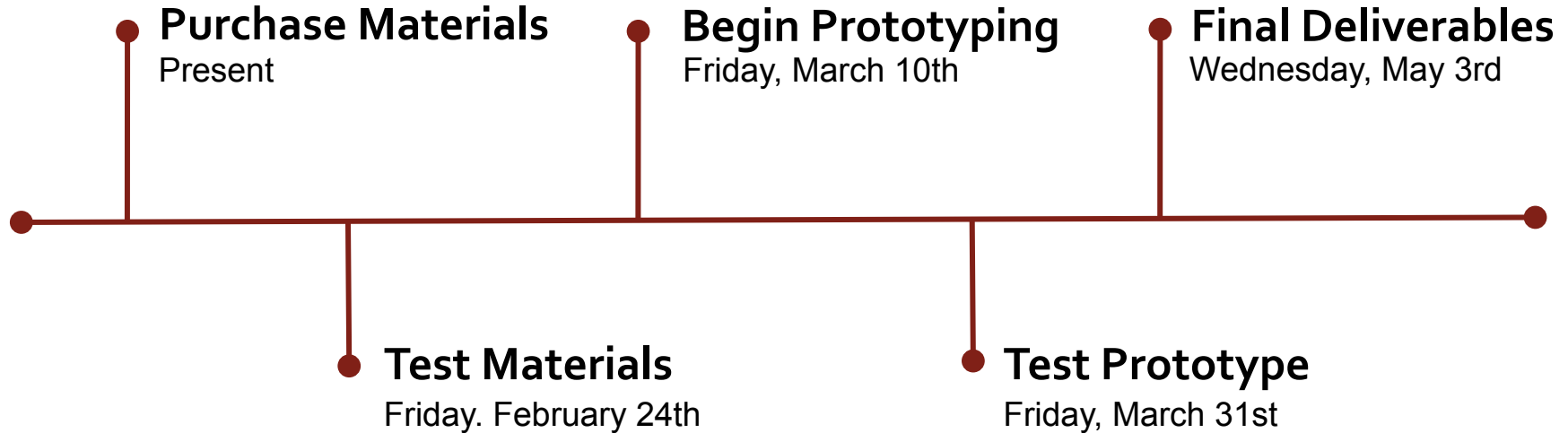

Special Thanks

Dr. John Puccinelli

Dr. Amit Nimunkar

BME Department



References

1. Sponsored by BINDER GmbH Apr 10 2014, "Application of binder incubators for human skin cell cultures," *AZoM.com*, 26-Apr-2019. [Online]. Available: <https://www.azom.com/article.aspx?ArticleID=10891>. [Accessed: 11-Oct-2021].
2. C.-P. Segeritz and L. Vallier, "Cell culture: Growing cells as model systems in vitro," *Basic Science Methods for Clinical Researchers*, 2017. [Online]. Available: <https://www.ncbi.nlm.nih.gov/pmc/articles/PMC7149418/>. [Accessed: 11-Oct-2021].
3. "White Paper No. 29 CO incubators – best practices." [Online]. Available: https://www.ependorf.com/product-media/doc/en/151861/Eppendorf_CO2-Incubators_White-Paper_029_CO2-Incubators_Best-Practices-Selection_Set-up-Care.pdf. [Accessed: 11-Oct-2021].
4. "Microscope Incubation Systems," *Elliot Scientific Website*, 2020. [Online]. Available: <https://www.elliotscientific.com/DPMH-Microscope-Incubators>. [Accessed: 23-Feb-2022].
5. "Proper care and maintenance for a Cell Culture Incubator." [Online]. Available: <https://assets.thermofisher.com/TFS-Assets/LED/Warranties/TNCO2CAREFEED-EN.pdf>. [Accessed: 11-Oct-2021].
6. A. Trapotsis, "Biosafety levels 1, 2, 3 & 4: What's the difference?," Consolidated Sterilizer Systems, 01-Apr-2020. [Online]. Available: <https://consteril.com/biosafety-levels-difference/>. [Accessed: 20-Sep-2021].
7. "Research IX71/IX81 - olympus america." [Online]. Available: https://www.olympusamerica.com/files/seg_bio/IX71/IX81%20brochure.pdf. [Accessed: 11-Oct-2021].
8. M. P. Walzika, V. Vollmar, T. Lachnit, H. Dietz, S. Haug, H. Bachmann, M. Fath, D. Aschenbrenner, S. A. Mofradab, O. Friedrich, and D. F. Gilbert, "A portable low-cost long-term live-cell imaging platform for biomedical research and education," *Biosensors and Bioelectronics*, vol. 64, pp. 639–649, Feb. 2015.
9. "10,000ppm MH-Z16 NDIR CO2 Sensor with I2C/UART 5V/3.3V Interface for Arduino/Raspberry Pi | Sandbox Electronics." <https://sandboxelectronics.com/?product=mh-z16-ndir-co2-sensor-with-i2cuart-5v3-3v-interface-for-arduinoraspeberry-pi> (accessed Feb. 06, 2023).
10. A. Industries, "Adafruit BME680 - temperature, humidity, pressure and gas sensor," adafruit industries blog RSS, 2020. [Online]. Available: <https://www.adafruit.com/product/3660>. [Accessed: 06-Feb-2023].
11. "MH-Z14A NDIR CO2 SENSOR FOR CARBON DIOXIDE DETECTION--Winsen." <https://www.winsen-sensor.com/sensors/co2-sensor/mh-z14a.html> (accessed Feb. 08, 2023).
12. techi, "ITO Coated Glass," Technistro. <https://www.technistro.com/ito-coated-glass/> (accessed Feb. 06, 2023).
13. Conductive Copper Tape 1" X 36yd." <https://www.sciplus.com/conductive-copper-tape-1-x-36yd-68713-p> (accessed Feb. 07, 2023).
14. B. Beranek, "Rear Defroster Diagnosis," Technically Speaking, Aug. 09, 2018. <https://beranek.agrrmag.com/2018/08/rear-defroster-diagnosis/> (accessed Feb. 07, 2023).
15. "Amazon.com: Coolerguys 25mm (25x25x10) USB Fan : Electronics." https://www.amazon.com/Coolerguys-25mm-25x25x10-USB-Fan/dp/B07NC4Z24T/ref=sr_1_8?keywords=microfan+usb&qid=1675989603&prefix=microfan+%2Caps%2C177&sr=8-8 (accessed Feb. 09, 2023).

Questions?

